

WOHNWELTEN MIT CHARAKTER
LIVING ENVIRONMENTS
WITH CHARACTER



21



Wohnkonzepte

Living concepts

Was macht aus Räumen ein Zuhause? Natürlich die Menschen, die dort leben. Hinzu kommt die Art, wie sie sich einrichten. Vom kleinsten Detail bis zur durchgängigen Gestaltung der einzelnen Räume – als Marktführer im Bereich Einbauküchen entwickeln wir seit Jahrzehnten hochwertige Systemmöbel mit hohem individuellen Planungsanspruch. Für uns die ideale Voraussetzung, um unsere Planungsexpertise und unseren hohen Anspruch an Qualität und Gebrauchsfähigkeit auch in den Bereichen Bad und Wohnen unter Beweis zu stellen. Und zwar ausgesprochen erfolgreich! Das Ergebnis: Wir führen Küche, Wohnen und Essen ganzheitlich zu einem Lebensraum zusammen. Für Ihr individuelles Zuhause!

—

What turns rooms into a home? The people who live there, of course. Plus the way they furnish them. From the smallest detail to the consistent design of the individual rooms – as a market leader in the fitted kitchen sector, we have been developing high-quality system furniture that meets high individual planning standards for decades. For us, this is the ideal prerequisite for demonstrating our planning expertise and our high standards of quality and usability, including in bathroom and living areas. And we do it with great success! The result: we combine kitchen, living and dining into one living space in a holistic way. For your individual home!

- 4** **Zuhause erleben** Experience your home
- 12** **Wohnwelten** Living environments
- 82** **Planungsvorschläge** Planning suggestions
- 99** **Dekore und Griffe** Décors and handles



Zuhause erleben Experience your home

**Für Familien ist der Tag immer in Bewegung, auch zuhause.
Hier spielen nicht nur die Kinder, hier spielt das Leben.
Schön, wenn die Einrichtung genau hierfür gemacht ist
und von morgens bis abends alles mitmacht.
Willkommen zuhause!**

—
For families, the day is always full of movement, even at home.
Not only do children play here, but this is where life plays out.
So it can only be a good thing if the furniture is made for exactly
this and can cope with everything that's thrown at it day and night.
Welcome home!







**DIE ANKLEIDE WIRD
ZUM KLEIDERTRAUM.**
TURN YOUR DRESSING ROOM
INTO A CLOTHING DREAM.



**GUTEN TAG!
HELLO!**

Fertig machen für die Arbeit, der Schulranzen ist gepackt, rein in die Jacken und los geht's. Nach Hause kommen, Gäste empfangen. Hier ist immer was los.

Get ready for work, pack the school satchel, pull your jackets on and off you go. Come home and welcome guests. There's always something going on here.



**WAHRE ORDNUNGS-LIEBE –
MIT DER PASSENDEN GARDEROBE.**
A TRUE LOVE OF ORDER –
WITH THE RIGHT WARDROBE.

**WENN DAS FAMILIENFRÜHSTÜCK
ZUM GENUSSMOMENT WIRD.**
WHEN THE FAMILY BREAKFAST
BECOMES A MOMENT TO ENJOY.



WENN WOHNEN ZUM WOHNGEFÜHL WIRD.
WHEN LIVING BECOMES A FEELING OF WELL-BEING.



ZUSAMMENKOMMEN GET TOGETHER

**Das Frühstück mit der Familie, ein gemeinsamer Spieleabend,
mit Freunden kochen oder einfach auf dem Sofa entspannen:
Hier ist Raum für alles.**

—
Breakfast with the family, an evening playing games together,
cooking with friends or simply relaxing on the sofa: there's space
for everything here.





14
Wohngefühl
Living atmosphere



58
Genussmoment
Moments of enjoyment

Wohnwelten

Living environments



68
**Ordnungs-
liebe**
A love of order

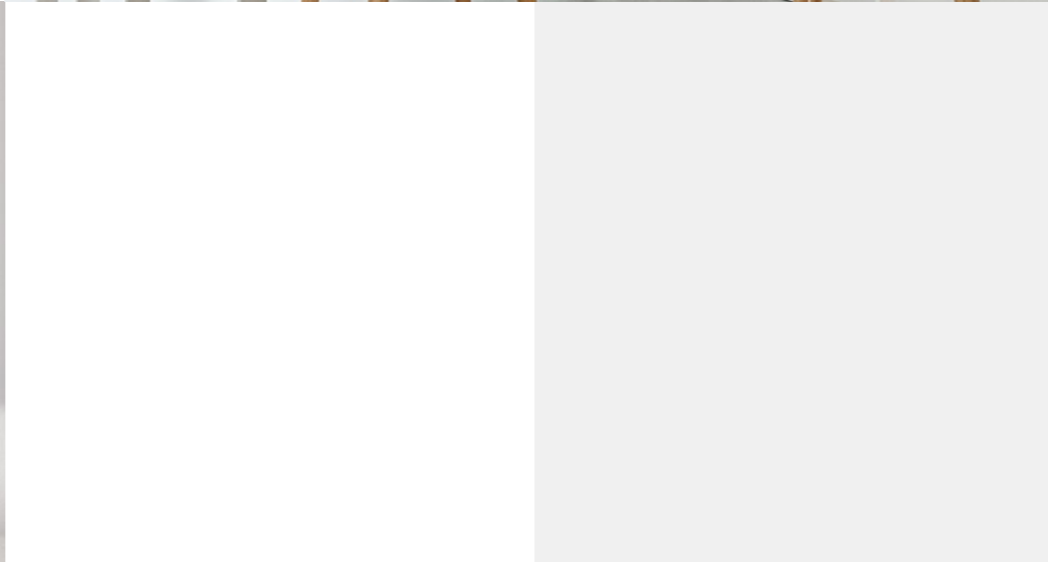

Individualität hat viele Gesichter. Daher bieten unsere Einrichtungselemente auch unendliche Möglichkeiten, einzelne Räume oder komplette Wohnwelten zu gestalten und zu verändern. Lassen Sie sich inspirieren!

—
Individuality has many faces. This is why our furnishing elements also offer unlimited possibilities for designing individual rooms or complete living environments as well as modifying them. Get some inspiration!



76
**Kleider-
traum**
Clothing dreams



Wohngefühl Living atmosphäre

Das Leben einfach nach den eigenen Vorstellungen gestalten. Unsere intelligenten und hochwertigen Systemmöbel bieten jede Menge Freiheit im Hinblick auf Materialien, Farben und Maße.

—
Design your life according to your own ideas. Our intelligent and high-quality system furniture offers lots of freedom when it comes to materials, colours and dimensions.





TOUCH

332 Lacklaminat, Alpinweiß supermatt

332 Lacquered laminate, alpine white supermatt

LEICHT GEMACHT MADE EASY

Helle Eiche Sierra plus mattweiße Fronten kreieren auf dezente Art eine besondere Leichtigkeit. Die Regale bieten die ideale Bühne für individuelle Dekorationen.

Light oak Sierra plus matt white fronts subtly create a special feeling of lightness. The shelves offer the ideal platform for individual decorative items.





KLARES DESIGN CLEAR DESIGN

Das Zusammenspiel von klaren Linien und supermatten Oberflächen in abgestimmten Graunuanzen wirkt elegant und sehr zeitgemäß.

The interplay of clear lines and super matt surfaces in coordinated grey shades creates an elegant and very contemporary impression.



TOUCH

341 Lacklaminat, Steingrau supermatt
341 Lacquered laminate, stone grey supermatt

TOUCH

334 Lacklaminat, Schiefergrau supermatt
334 Lacquered laminate, slate grey supermatt

RUNDUM GELUNGEN AN ALL-ROUND SUCCESS

Dieses Sideboard-Arrangement wurde auf dem Boden stehend geplant, eine sehr zeitgemäße Interpretation zum Thema Stauraum. Für Harmonie sorgen seidengraue Elemente mit betont schlichten Griffen kombiniert mit der warmen Beton-Nuance Terragrau. Definitives Highlight im Wohnbereich: die runden Wangen.

—
This sideboard arrangement was designed to stand on the floor, a very contemporary interpretation of storage space. A sense of harmony is achieved by satin grey elements with deliberately simple handles combined with the warm concrete shade Terra grey. A definite highlight in the living area: the round upright panels.



TOUCH

—
338 Lacklaminat, Seidengrau supermatt
338 Lacquered laminate, satin grey supermatt

RIVA

—
839 Beton Terragrau Nachbildung
839 Concrete Terra grey reproduction



FASHION

168 Lack, Alpinweiß matt
168 Lacquer, honed alpine white

STRUCTURA

402 Eiche Havanna Nachbildung
402 Havana oak reproduction

NATÜRLICH KOMBINIERT NATURALLY COMBINED

Die Materialkombination aus der warmen Eiche Havanna und alpinweißer Oberfläche schafft eine spannende und dennoch wohnliche Atmosphäre. Schöner Blickfang: eine lockere Planung, die durch beleuchtete Wandborde betont wird.

—
The combination of materials in the form of warm Havana oak and alpine white surfaces creates an exciting but homely atmosphere. Lovely eye-catcher: a casual design that is emphasised by illuminated wall-mounted shelves.





STRUCTURA

403 Eiche Nero Nachbildung
403 Nero oak reproduction

EASYTOUCH

963 Lacklaminat, Rostrot ultramatt
963 Lacquered laminate, rust red ultra matt



ANTI
FINGER
PRINT

STATEMENT STATEMENT

Ein starker Auftritt für ein sehr aktuelles Ambiente. Die Kunst des Wohnens präsentiert sich in schwarzer Eiche Nero kombiniert mit Auszügen in ultramattem Rostrot. Schön praktisch: die Anti-Fingerprint Beschichtung.

A strong appearance for a very contemporary ambience. The art of living is presented in black Nero oak with pull-outs in ultra matt rust red. Amazingly practical: anti-fingerprint coating.



PURE ELEGANZ
PURE ELEGANCE

Ein Wohntrend, der mit spannenden Materialkontrasten, einer minimalistischen Formensprache und dunklen Tönen einen wirklich exklusiven Stil kreiert. Die Kombination aus modernem Nussbaum-Dekor und glänzendem Schwarz ist ein echtes Statement.

A living trend that creates a truly exclusive style with exciting material contrasts, a minimalist design language and dark tones. The combination of modern walnut décor and shiny black make a real statement.

MODERNE GERADLINIGKEIT MODERN STRAIGHT LINES

Eine durchdachte Klarheit ist typisch für diese Planung, die komplett ohne sichtbare Griffe auskommt. Exklusiver Blickfang im Designer-Look: Die hohe Version des dunklen Glaswandschranks Flat inszeniert Stauraum sehr individuell.

Well conceived clarity is typical of this design, which is realised completely without handles. Exclusive eye-catcher in a designer look: the tall version of the dark glass wall unit Flat showcases storage space in a very individual way.



RIVA

840 Nussbaum Nachbildung
840 Walnut reproduction





TOUCH

341 Lacklaminat, Steingrau supermatt
341 Lacquered laminate, stone grey supermatt

ENTSPANNTE NATÜRLICHKEIT RELAXED NATURALNESS

Zur Ruhe kommen und entspannen, das funktioniert mit viel Holz, natürlichen Farben und warmen Lichtquellen besonders gut. Das luftige Regal- und Ablageelement in heller Eiche San Remo kreiert ein offenes Wohlfühlambiente und inszeniert die Lieblings-Accessoires.

Relax and unwind: this is particularly easy with lots of wood, natural colours and sources of warm light. The airy shelf and storage element in light Sanremo oak creates an open feel-good ambience and showcases your favourite accessories.





TOUCH

334 Lacklaminat, Schiefergrau supermatt
334 Lacquered laminate, slate grey supermatt



ZEITLOS MODERN TIMELESSLY MODERN

Das grifflose Design der Wandelemente zeigt sich ausgesprochen modern und elegant. In der Kombination mit edlen Hölzern entsteht so ein zeitloser Look, der jeden Raum bereichert.

The handleless design of the wall elements looks exceptionally modern and elegant. Combined with fine woods, this creates a timeless look that enriches any room.





ANSICHTSSACHE A MATTER OF OPINION

Für ein neues, spannendes Materialgefühl sorgen jetzt Schrank-
elemente mit matt satinierten Fronten, die mit ihrer außergewöhn-
lichen Glasoptik eine optische Tiefe erzeugen. Unterstrichen wird
dieser raffinierte Effekt durch die besondere Kantenform.

Cabinet elements with matt satin fronts now provide a new, exciting
material feel, creating an optical depth with their extraordinary glass
look. This sophisticated effect is underlined by the special edge shape.

ARTIS

937 Glasoptik, Titanio matt
937 Glass appearance, Titanio matt





STRUCTURA

—
402 Eiche Havanna Nachbildung
 402 Havana oak reproduction

AUFGESCHOBEN MOVED

TOUCH

—
340 Lacklaminat, Schwarz supermatt
 340 Lacquered laminate, black supermatt



Schiebetüren als Gestaltungselement schaffen Stauraum und geben den Möbeln im naturbelassenen Eiche Havanna Look einen coolen Touch.

—
 Sliding doors as a design element create storage space and give the furniture in natural Havana oak look a cool touch.



ANTI
FINGER
PRINT

EASYTOUCH

963 Lacklaminat, Rostrot ultramatt

963 Lacquered laminate, rust red ultra matt



RIVA

889 Beton schiefergrau Nachbildung

889 Concrete Slate Grey reproduction

STARKE OPTIK STRONG LOOKS

Ein individuelles Ensemble mit Wow-Effekt. Die Rückwand im Beton-Look schafft den perfekten Rahmen für kontrastierende Schränke in Rostrot mit ultramatten Anti-Fingerprint Oberflächen.

An individual ensemble with the wow factor. The rear wall in a concrete look creates the perfect backdrop for contrasting cupboards in rust red with ultra matt anti-fingerprint surfaces.

URBANE GEMÜTLICHKEIT URBAN COSINESS

Ein Wohnstil, der auf entspannte Art urban und wohnlich zugleich wirkt. Natürliche Materialien, sanfte Farbtöne und dekorative Grünpflanzen schaffen das ideale Umfeld für sehr zeitgemäße Systemmöbel in hochwertigen Holzoptiken. Trend-Thema: Oberflächen zeigen sich jetzt betont pur und in natürlichen Sandtönen.

A style that looks both urban and homely at the same time, and in a relaxed way. Natural materials, soft shades and decorative green plants create the ideal environment for very contemporary system furniture in a high-quality wood appearance. On-trend theme: surfaces now appear emphatically pure and in natural sand tones.





EASYTOUCH

969 Lacklaminat, Sand ultramatt

969 Lacquered laminate, sand ultra matt



RIVA

840 Nussbaum Nachbildung

840 Walnut reproduction

ÜBERRASCHENDE DETAILS SURPRISING DETAILS

Doppelt schön – und praktisch. Die variablen Smartcube Regale inszenieren individuelle Deko-Ideen und die puristischen Schrankelemente bieten nicht nur Stauraum, sondern überzeugen mit praktischen Barklappen. Smarte Idee: ein integrierter Kabeldurchlass.

Doubly beautiful – and practical. The variable Smartcube shelves showcase individual decorative ideas and the puristic cupboard elements not only offer storage space, but also impress with practical bar flaps. Smart idea: an integrated cable pass-through.





MARMOR STYLE MARBLE STYLE

Cool kombiniert! Die Marmor Teramo Nachbildung gibt den Hängemodulen mit Barklappen ihren puren und individuellen Touch und passt sich unterschiedlichen Wohnstilen gekonnt an.

Cool combination! The Teramo marble reproduction gives the suspended units with fold down fronts their pure and individual touch. This fits with different living styles.

COLOR CONCEPT

274 Marmor Teramo Nachbildung
274 Teramo marble reproduction

TOUCH

338 Lacklaminat, Seidengrau supermatt
338 Lacquered laminate, satin grey supermatt

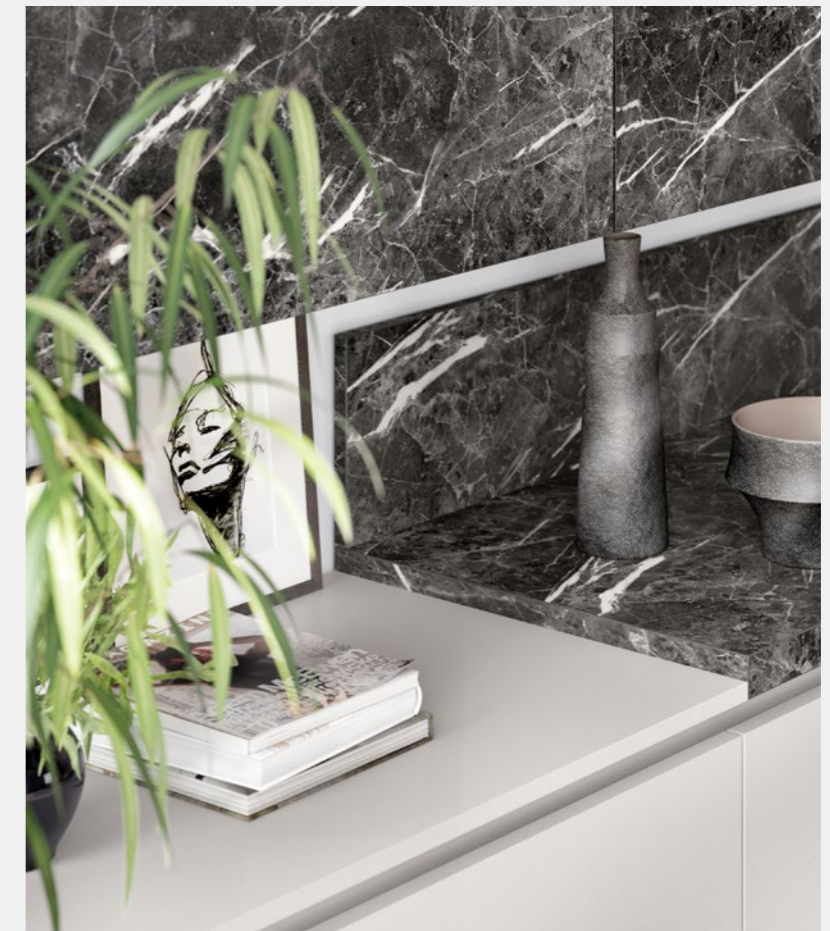

KONTRASTVOLLE SCHÖNHEIT CONTRASTING BEAUTY

Starke Kontraste in Schwarz und Weiß wirken klassisch, hochwertig und zeitlos. Dazu eine grafische Formsprache sowie individuelle Accessoires. Für ein Zuhause, das mit Persönlichkeit überzeugt und in dem die Einrichtung effektiv in Szene gesetzt wird.

—
Strong contrasts in black and white look classic, high quality and timeless. Coupled with a graphical design language and individual accessories for a home that impresses with its personality and that effectively showcases the furnishings.

KLAR URBAN CLEARLY URBAN

Hell trifft dunkel und schafft so eine klare, urbane Ästhetik. Basics zum Look: Schränke und Regale mit schwarzem Korpus und pflegeleichten Anti-Fingerprint-Fronten. Glas als Designelement bringt eine zusätzliche Leichtigkeit.

Light meets dark, creating a clear, urban aesthetic. Basics for the look: units and shelf units with black carcass and easy-care anti-fingerprint fronts. Glass as a design element provides additional lightness.



ANTI
FINGER
PRINT

EASYTOUCH

967 Lacklaminat, Alpinweiß ultramatt
967 Lacquered laminate, alpine white ultra matt

EASYTOUCH

961 Lacklaminat, Grafit schwarz ultramatt
961 Lacquered laminate, graphite black ultra matt



SPIELRAUM FREEDOM TO PLAY

So vielseitig kann eine moderne Stauraumgestaltung aussehen. Hingucker: die integrierte Pultplatte in strukturierter Eiche Sierra Optik setzt als Designelement ein starkes Zeichen.

—
Modern storage design can look this versatile. Eye-catcher: the integrated console panel in a structured Sierra oak look makes a strong statement as a design element.



FASHION

—
173 Lack, Weiß matt
173 Lacquer, honed white





FRISCHEKICK A FRESHNESS BOOST

Der Landhaus-Trend begeistert mit einer frischen und gemütlichen Wohnlichkeit, die durch nordisch inspirierte, moderne Landhausfronten noch unterstrichen wird. Offene Schrankfächer bieten Platz für persönliche Deko-Ideen. Der integrierte Kabeldurchlass ist ein praktisches Detail.

The cottage style trend inspires with a fresh and cosy homeliness that is further underlined by Scandinavian-inspired, modern cottage style fronts. Open unit compartments offer space for personal decoration ideas. The integrated cable pass-through is a practical detail.

NORDIC

782 Lack, Weiß matt

782 Lacquer, honed white



LUX

823 Lack, Schiefergrau Hochglanz
823 Lacquer, slate grey high gloss

STRUCTURA

402 Eiche Havanna Nachbildung
402 Havana oak reproduction



AKZENTE SETZEN SETTING ACCENTS

Das Wandsystem in schiefergrauem Hochglanz überzeugt durch sein Design und die praktischen Auszüge. Schöner Kontrast: Elemente aus Eiche Havanna.

The wall system in slate-grey high gloss inspires with its design and practical pull-outs. Beautiful contrasting elements made from Havana oak.



EASYTOUCH

961 Lacklaminat, Grafit-schwarz ultramatt

961 Lacquered laminate, graphite black ultra matt



RIVA

892 Beton grau Nachbildung

892 Concrete grey reproduction

GRAUSTUFEN GREYSSCALE

Puristische Auszüge in Beton-Optik und grafit-schwarze Elemente mit praktischer Anti-Fingerprint Beschichtung werden von der Rückwand zu einem harmonischen Gesamtbild zusammengeführt. Eine starke Kombination, die cool und elegant zugleich wirkt.

Puristic pull-outs in a concrete look and graphite black elements with a practical anti-fingerprint coating are brought together by the rear wall, forming a harmonious feature. A strong combination that looks both cool and elegant.



Genuss- moment

Moments of enjoyment

**Essen genießen, wie und wo man es mag.
Wenn Kochen, Essen und Wohnen fließend
ineinander übergehen, sorgen unsere Möbel
für die passende Verbindung.**

—
Enjoy your food how and wherever you want.
When cooking, eating and living merge seam-
lessly into one another, our furniture provides
the ideal links between them.





STRUCTURA

405 Eiche Sierra Nachbildung
405 Sierra oak reproduction

LEICHTIGKEIT
LIGHTNESS

Genuss gut geplant! Ein Essbereich, in dem dank einer klaren Formsprache und exklusiven Oberflächengestaltung alles perfekt zusammen passt.

Well-planned enjoyment! A dining area in which everything fits together perfectly thanks to a clear design language and exclusive surface design.





TOUCH

341 Lacklaminat, Steingrau supermatt
341 Lacquered laminate, stone grey supermatt

TOUCH

340 Lacklaminat, Schwarz supermatt
340 Lacquered laminate, black supermatt

EINLADEND INVITING

Kreativ geplant! Frische Kräuter sind jetzt jederzeit griffbereit am Tisch. Auszüge bieten jede Menge Stauraum für Gläser und Geschirr. Und das Design des Tisches rundet das Gesamtbild ästhetisch ab.

Creatively planned! Fresh herbs are now always within reach at the table. Pull-outs offer lots of storage space for glasses and crockery. And the design of the table completes the overall aesthetic.





RIVA

840 Nussbaum Nachbildung
840 Walnut reproduction

AUTHENTISCH & ELEGANT AUTHENTIC AND ELEGANT

Die ausdrucksstarke Wohnwand in edler Nussbaum-Optik überzeugt innen wie außen. Praktische Auszüge, Schubladen und Regalflächen für Deko-Objekte machen sie zu einem zeitlosen Stauraumwunder. Der passende Tisch dazu schafft ein ruhiges und wohnliches Ambiente.

The expressive wall in fine walnut appearance impresses both inside and out. Practical pull-outs, drawers and shelf space for decorative objects make them a timeless storage wonder. The matching table creates a calm and homely ambience.



KOMPLETTPROGRAMM COMPLETE RANGE

Die warmen Eiche Sierra Oberflächen verbinden Wohnen und Essen auf sehr moderne Art und gestalten den Raum ganzheitlich. Seidengraue Elemente unterstreichen diesen entspannten Stil perfekt.

The warm Sierra oak surfaces combine living and eating in a very modern way and ensures a holistic design for the room. Satin grey elements perfectly underpin this relaxed style.



TOUCH

338 Lacklaminat, Seidengrau supermatt
338 Lacquered laminate, satin grey supermatt

STRUCTURA

405 Eiche Sierra Nachbildung
405 Sierra oak reproduction



Ordnungs- liebe

A love of order

Am Flur führt in der Regel kein Weg vorbei. Schön, wenn sich dieser Bereich für Gäste repräsentativ und gut organisiert gestaltet.

—
There is no way around the hall to get to the rest of the house. Even better if you can make this area a showcase for guests and get it well organised.



PLATZ GENUG ENOUGH SPACE

Variabilität in bester Form. Das Stollen-Regalsystem ist beliebig erweiterbar und wird durch Schränke, Auszüge, Ablagen und Kleiderstangen zu einem wahren Raumwunder. Highlight: die Stollen können optional mit integrierter Beleuchtung ausgestattet werden.

Variability at its best. The pole-mounted shelving system can be extended at will and becomes a true space miracle with cupboards, pull-outs, shelves and clothes rails. Highlight: the pole-mounted shelving can be optionally equipped with integrated lighting.



TOUCH

334 Lacklaminat, Schiefergrau supermatt
334 Lacquered laminate, slate grey supermatt





ORGANISATIONSTALENT ORGANISATIONAL TALENT

Diese Garderobe beweist ihr Organisationstalent täglich auf's Neue. Durch Ablageflächen, Auszüge und Kleiderstange hilft sie den Alltag zu organisieren. Praktisch, wenn Schlüssel und Handy griffbereit abgelegt werden können und Schal und Schirm ihren Platz finden. Und dann noch der rasche Blick in den beleuchteten Spiegel.

—
This hanging and drawer system is a useful addition to any household every day. With shelves, pull-outs and clothes rails, it helps to organise everyday life. Practical: keys and mobile phones can be stored within easy reach and your scarf and umbrella have a designated place. And then a quick glance in the illuminated mirror.



STRUCTURA

—
405 Eiche Sierra Nachbildung
405 Sierra oak reproduction



EASYTOUCH

—
961 Lacklaminat, Grafit-schwarz ultramatt
961 Lacquered laminate, graphite black ultra matt



ANTI
FINGER
PRINT

LUX

819 Lack, Seidengrau Hochglanz
819 Lacquer, satin grey high gloss



KONTRASTPROGRAMM CONTRASTING PROGRAMME

Bruchstein-Optik trifft hier auf ein optional indirekt beleuchtetes Stollen-Regalsystem, das bei der ganzen Familie mit Schubladen, hohen Auszügen und einem Spiegel punktet. Eine spannende Kombination, die den Alltag bereichert. Schöne Alternative: ein größerer Spiegel mit praktischer Ablagefläche.

A quarry stone look meets an optional indirectly illuminated pole-mounted shelving system that looks stunning with its co-ordinated drawers, high pull-outs and a mirror. An exciting combination that enriches everyday life. A nice alternative: a larger mirror with a practical storage surface.



Kleidertraum

Clothing dreams

Die eigene Ankleide muss kein Traum bleiben. Intelligente Module und praktische Detaillösungen passen sich jeder Raumgröße an und bringen auf stilvolle Art Ordnung ins Leben.

—
Having your own dressing room need not remain a dream. Intelligent modules and practical detail solutions can adapt to all sizes of room and bring order to life in a stylish way.





TOUCH

334 Lacklaminat, Schiefergrau supermatt

334 Lacquered laminate, slate grey supermatt

MEHR FLEXIBILITÄT GREATER FLEXIBILITY

Stilvoll und flexibel zugleich. Das variable Stollen-Regalsystem bietet mit seinen Ablageböden, Schubladen, Auszügen und Kleiderstangen viel Platz für Kleidung und Accessoires und ist zudem beliebig erweiterbar.

Stylish and flexible at the same time. With its shelves, drawers, pull-out drawers and clothes rails, the variable pole-mounted shelving system offers lots of space for clothing and accessories and can also be extended as required.





TOUCH

341 Lacklaminat, Steingrau supermatt
341 Lacquered laminate, stone grey supermatt

RAUMWUNDER A SPACE MIRACLE

Der wohnliche Ankleidebereich mit viel Raum für Kleidung und andere Lieblingsstücke bietet ideale Voraussetzungen für individuelle Planungen. Die perfekte Synthese aus dem klassischen Systemmöbel und dem Stollen-Regalsystem erfüllt so unterschiedlichste Ansprüche.

The cosy dressing area with lots of space for clothing and other favourite pieces offers the ideal storage solutions for individual plans. The perfect synthesis of classic system furniture and the pole-mounted shelving system meets the most varied of demands.



PLANUNGSVORSCHLÄGE

Unsere Wohnmöbel können Sie immer individuell und passend für Ihre Bedürfnisse kombinieren. Ihr Fachhändler vor Ort unterstützt Sie gerne bei der Planung.

PLANNING SUGGESTIONS

You can always combine our furniture individually to suit your needs. Your local dealer will be happy to help you with your plans.

WSET02

Seite 14-17
page 14-17

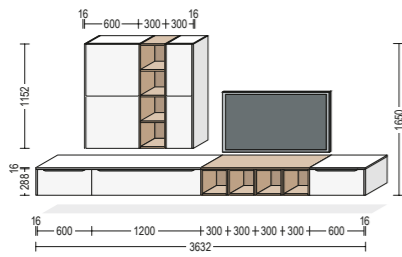

WSET01

Seite 18-19
page 18-19

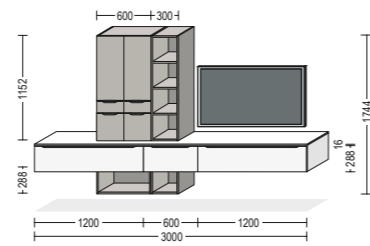

WSET14

Seite 20-21
page 20-21

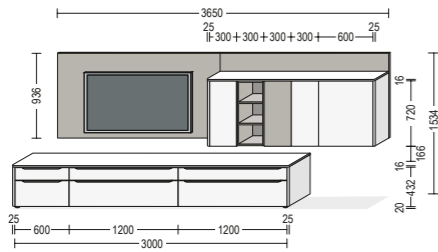

WSET05

Seite 22-23
page 22-23

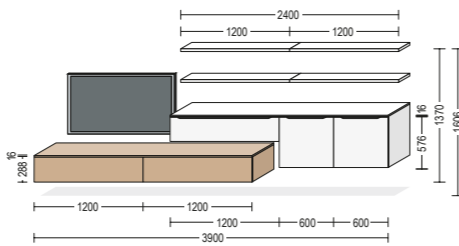

WSET04

Seite 24-25
page 24-25

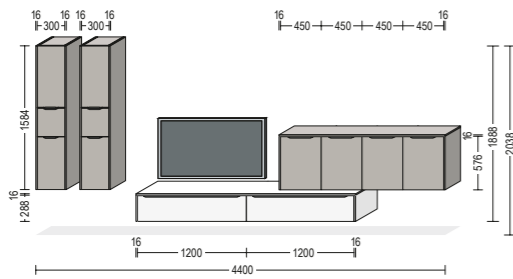

WSET17

Seite 26-29
page 26-29

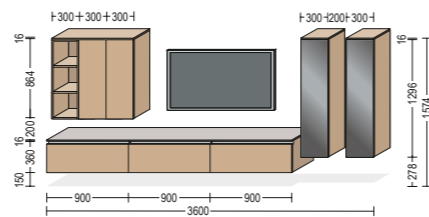

WSET06

Seite 30-31
page 30-31

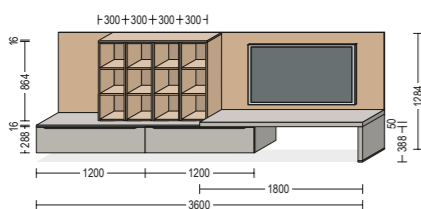

WSET09

Seite 32-33
page 32-33

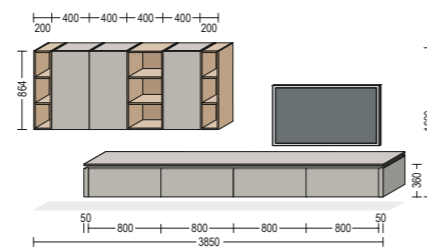

WSET18

Seite 34-35
page 34-35

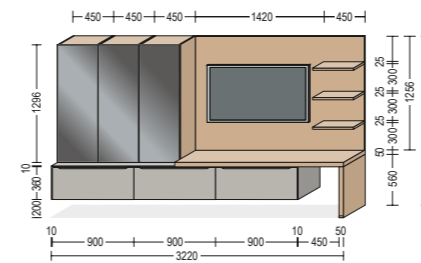

WSET15

Seite 38-39
page 38-39

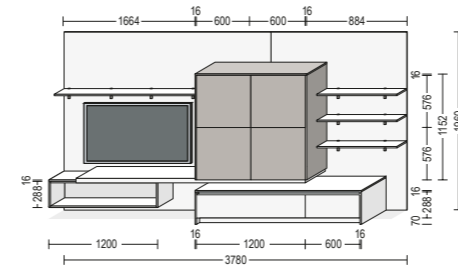

WSET13

Seite 44-45
page 44-45

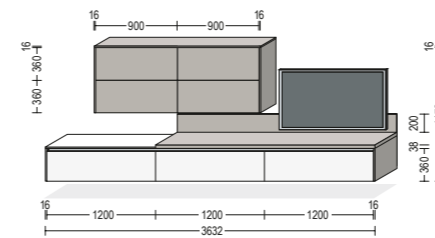

WSET11

Seite 36-37
page 36-37

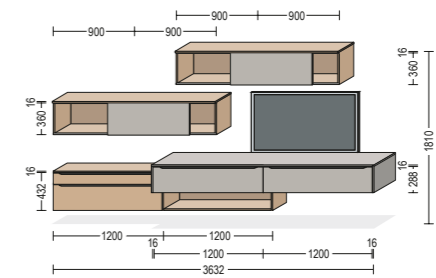

WSET08

Seite 40-43
page 40-43

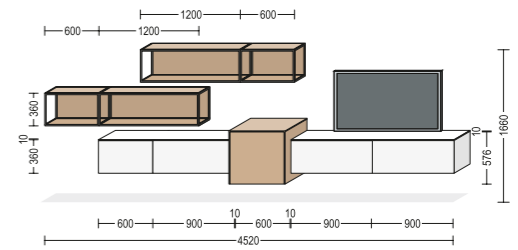

WSET12

Seite 46-49
page 46-49

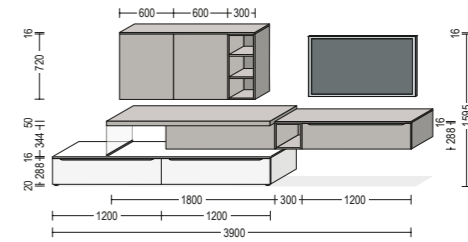

WSET10

Seite 50-51
page 50-51

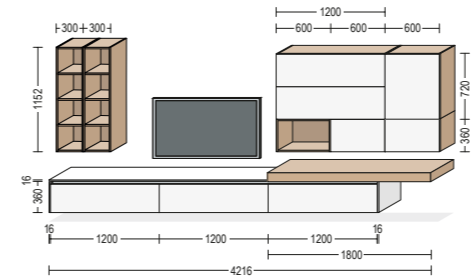

WSET16

Seite 52-53
page 52-53

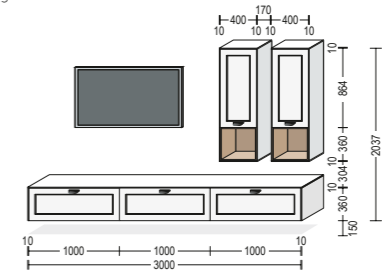

WSET03

Seite 54-55
page 54-55

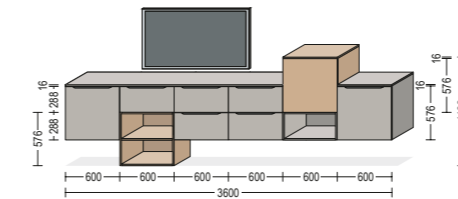

WSET07

Seite 56-57
page 56-57

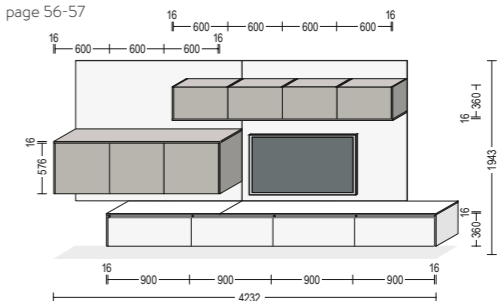

Spezifikationen Specifications

Die Planungsvorschläge enthalten keine Leuchten, Griffleisten-Mehrpriese oder Steckdosen. Diese müssen zusätzlich zur Set-Artikelnummer bestellt werden. Sondermaße gegen Mehrpreis. TV-Geräte und Dekorationsartikel sind nicht enthalten.
 The design suggestions do not contain any lights, bar handle surcharges or sockets. These must be ordered in addition to the set item number. Special dimensions for a surcharge. TVs and decorative items are not included.

Wohngefühl Living atmosphere

WSET01

Seite 18-19
page 18-19

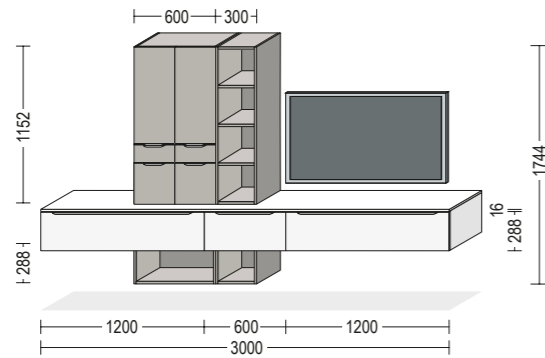

- 2 × BUA 120-29 **Badezimmer-Auszugschrank, 1 Auszug, B × H × T: 1200 × 288 × 461 mm**
Bathroom pull-out unit, 1 pull-out, w × h × d: 1200 × 288 × 461 mm
- 1 × WR 60-36 **Wandregal, B × H × T: 600 × Sondermaß 288 × 371 mm**
Open shelf wall unit, w × h × d: 600 × special size 288 × 371 mm
- 1 × WR 30-36 **Wandregal, B × H × T: 300 × Sondermaß 288 × 371 mm**
Open shelf wall unit, w × h × d: 300 × special size 288 × 371 mm
- 1 × BUA 60-29 **Badezimmer-Auszugschrank, 1 Auszug, B × H × T: 600 × 288 × 461 mm**
Bathroom pull-out unit, 1 pull-out, w × h × d: 600 × 288 × 461 mm
- 1 × APSLN60 **Arbeitsplatte APSLN Slim Line, 16 mm stark, B × T: 3004 × 487 mm**
Slim Line Worktop APSLN, 16 mm thick, w × d: 3004 × 487 mm
- 2 × BMSA 30-115 **Badezimmer-Midischrank, 1 Tür, 1 Schubkasten, 1 Auszug, 2 Einlegeböden, B × H × T: 300 × 1152 × 350 mm**
Bathroom Midi unit, 1 door, 1 drawer, 1 pull-out, 2 shelves, w × h × d: 300 × 1152 × 350 mm
- 1 × BMR 30-115 **Badezimmer-Midiregal, 3 feste Böden, B × H × T: 300 × 1152 × 371 mm**
Bathroom Midi shelf unit, 3 fixed shelves, w × h × d: 300 × 1152 × 371 mm

*Bitte beachten Sie, dass ein Distanzband für die Montage erforderlich ist, um Kollisionen zwischen der Front und den horizontal angebrachten Teilen zu vermeiden.
 *Please note that a spacer tape is required when planning top shelves, and folding/lifting door and swivel flap units, to prevent the front from contacting the top shelf.

Wohngefühl Living atmosphere

WSET03*

Seite 54-55
page 54-55

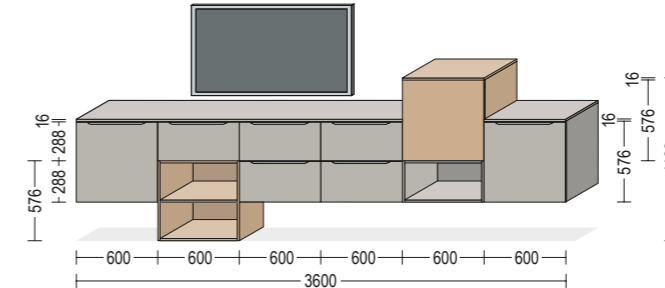

- 3 × BU 60-58 **Badezimmer-Unterschrank, 1 Tür, 1 Einlegeboden, B × H × T: 600 × 576 × 461 mm**
Bathroom base unit, 1 door, 1 shelf, w × h × d: 600 × 576 × 461 mm
- 1 × BUR 60-58 **Badezimmer-Unterschrankregal, 1 fester Boden, B × H × T: 600 × 576 × 482 mm**
Bathroom open shelf base unit, 1 fixed shelf, w × h × d: 600 × 576 × 482 mm
- 1 × BUA 60-29 **Badezimmer-Auszugschrank, 1 Auszug, B × H × T: 600 × 288 × 461 mm**
Bathroom pull-out unit, 1 pull-out, w × h × d: 600 × 288 × 461 mm
- 2 × BU2A 60-58 **Badezimmer-Auszugschrank, 2 Auszüge, B × H × T: 600 × 576 × 461 mm**
Bathroom pull-out unit, 2 pull-outs, w × h × d: 600 × 576 × 461 mm
- 1 × BUR 60-29 **Badezimmer-Unterschrankregal, B × H × T: 600 × 288 × 482 mm**
Bathroom open shelf base unit, w × h × d: 600 × 288 × 482 mm
- 1 × ADB16 49 **Abdeckboden, 16 mm stark, B × T: 2402 × 487 mm**
Top shelf, 16 mm thick, w × d: 2402 × 487 mm
- 1 × ADB16 49 **Abdeckboden, 16 mm stark, B × T: 604 × 487 mm**
Top shelf, 16 mm thick, w × d: 604 × 487 mm
- 1 × ADB16 49 **Abdeckboden, 16 mm stark, B × T: 602 × 487 mm**
Top shelf, 16 mm thick, w × d: 602 × 487 mm
- 1 × PTO5 **Mechanische Öffnungsunterstützung**
Mechanical opening support mechanism

WSET02

Seite 14-17
page 14-17

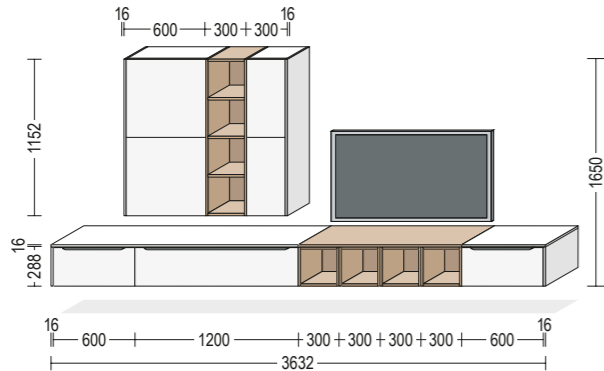

- 2 × BUA 60-29 **Badezimmer-Auszugschrank, 1 Auszug, B × H × T: 600 × 288 × 461 mm**
Bathroom pull-out unit, 1 pull-out, w × h × d: 600 × 288 × 461 mm
- 1 × BUA 120-29 **Badezimmer-Auszugschrank, 1 Auszug, B × H × T: 1200 × 288 × 461 mm**
Bathroom pull-out unit, 1 pull-out, w × h × d: 1200 × 288 × 461 mm
- 4 × BUR 30-29 **Badezimmer-Unterschrankregal, B × H × T: 300 × 288 × 482 mm**
Bathroom open shelf base unit, w × h × d: 300 × 288 × 482 mm
- 1 × ADB16 49 **Abdeckboden, 16 mm stark, B × T: 1818 × 487 mm**
Top shelf, 16 mm thick, w × d: 1818 × 487 mm
- 1 × ADB16 49 **Abdeckboden, 16 mm stark, B × T: 1200 × 487 mm**
Top shelf, 16 mm thick, w × d: 1200 × 487 mm
- 1 × ADB16 49 **Abdeckboden, 16 mm stark, B × T: 618 × 487 mm**
Top shelf, 16 mm thick, w × d: 618 × 487 mm
- 2 × BUW 16-29 **Abschlusswange, 16 mm stark, H × T: 288 × 485 mm**
Upright at end of run, 16 mm thick, h × d: 288 × 485 mm
- 2 × W 60-1 **Wandschrank, 1 Tür, 1 Einlegeboden, B × H × T: 600 × Sondermaß 576 × 350 mm**
Wall unit, 1 door, 1 shelf, w × h × d: 600 × special size 576 × 350 mm
- 1 × BMR 30-115 **Badezimmer-Midiregal, 3 feste Böden, B × H × T: 300 × 1152 × 371 mm**
Bathroom Midi shelf unit, 3 fixed shelves, w × h × d: 300 × 1152 × 371 mm
- 2 × W 30-1 **Wandschrank, 1 Tür, 1 Einlegeboden, B × H × T: 300 × Sondermaß 576 × 350 mm**
Wall unit, 1 door, 1 shelf, w × h × d: 300 × special size 576 × 350 mm
- 2 × BMW 16-115 **Abschlusswange, 16 mm stark, H × T: 1152 × 374 mm**
Upright at end of run, 16 mm thick, h × d: 1152 × 374 mm
- 1 × PTO5 **Mechanische Öffnungsunterstützung**
Mechanical opening support mechanism

WSET04*

Seite 24-25
page 24-25

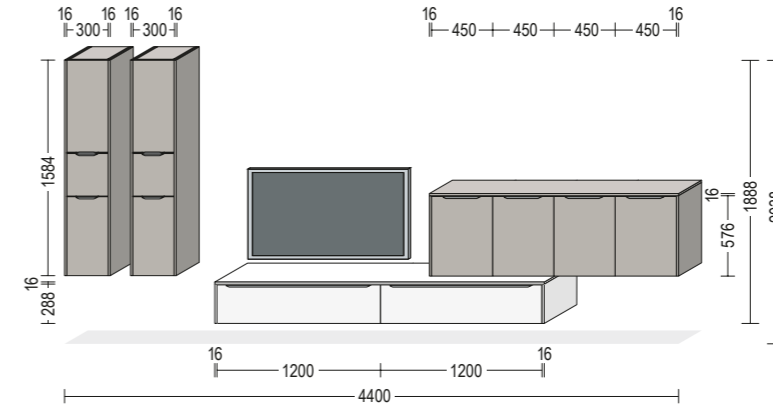

- 2 × BMA 30-158 **Badezimmer-Midischrank, 1 Tür, 1 Auszug, 1 Tür, 3 Einlegeböden, B × H × T: 300 × 1584 × 350 mm**
Bathroom Midi unit, 1 door, 1 pull-out, 1 door, 3 shelves, w × h × d: 300 × 1584 × 350 mm
- 4 × BMW 16-158 **Abschlusswange, 16 mm stark, H × T: 1584 × 374 mm**
Upright at end of run, 16 mm thick, h × d: 1584 × 374 mm
- 2 × BUA 120-29 **Badezimmer-Auszugschrank, 1 Auszug, B × H × T: 1200 × 288 × 461 mm**
Bathroom pull-out unit, 1 pull-out, w × h × d: 1200 × 288 × 461 mm
- 1 × ADB16 49 **Abdeckboden, 16 mm stark, B × T: 2436 × 487 mm**
Top shelf, 16 mm thick, w × d: 2436 × 487 mm
- 2 × BUW 16-29 **Abschlusswange, 16 mm stark, H × T: 288 × 485 mm**
Upright at end of run, 16 mm thick, h × d: 288 × 485 mm
- 4 × W 45-1 **Wandschrank, 1 Tür, 1 Einlegeboden, Griff oben, B × H × T: 450 × Sondermaß 576 × 350 mm**
Wall unit, 1 door, 1 shelf, handle at top, w × h × d: 450 × special size 576 × 350 mm
- 4 × MP-SB **Mehrpriese Sideboard**
Surcharge for sideboard
- 1 × ADB16 38 **Abdeckboden, 16 mm stark, B × T: 1836 × 376 mm**
Top shelf, 16 mm thick, w × d: 1836 × 376 mm
- 1 × BUW 16-58 **Abschlusswange, 16 mm stark, H × T: 579 × Sondermaß 374 mm**
Upright at end of run, 16 mm thick, h × d: 579 × special size 374 mm
- 1 × BUW 16-58 **Abschlusswange, 16 mm stark, H × T: 576 × Sondermaß 374 mm**
Upright at end of run, 16 mm thick, h × d: 576 × special size 374 mm

Spezifikationen Specifications

Die Planungsvorschläge enthalten keine Leuchten, Griffleisten-Mehrpreise oder Steckdosen. Diese müssen zusätzlich zur Set-Artikelnummer bestellt werden. Sondermaße gegen Mehrpreis. TV-Geräte und Dekorationsartikel sind nicht enthalten.
The design suggestions do not contain any lights, bar handle surcharges or sockets. These must be ordered in addition to the set item number. Special dimensions for a surcharge. TVs and decorative items are not included.

Wohngefühl Living atmosphere

WSET05

Seite 22-23
page 22-23

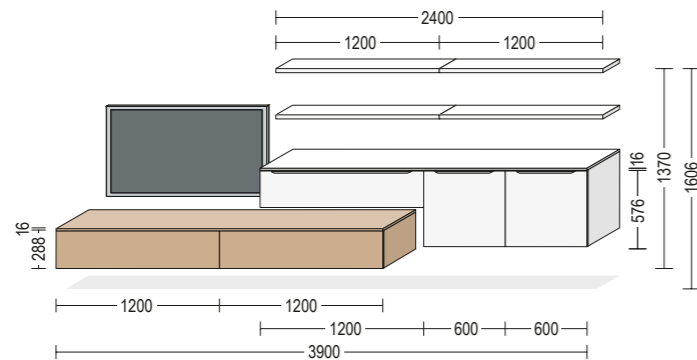

- | | | | |
|----------------|---|--------------|--|
| 3 × BUA 120-29 | Badezimmer-Auszugschrank, 1 Auszug, B × H × T: 1200 × 288 × 461 mm
Bathroom pull-out unit, 1 pull-out, w × h × d: 1200 × 288 × 461 mm | 4 × WBLG 120 | LED Glas-Lichtbord, 30 mm stark, B × T: 1200 × 200 mm
LED glass lighted wall shelf, 30 mm thick, w × d: 1200 × 200 mm |
| 2 × SOS-SET | Sensomatic Öffnungssystem
Sensomatic opening system | 1 × LSET60 | LED-Startset
LED starter set |
| 2 × ADB16 49 | Abdeckboden, 16 mm stark, B × T: 2404 × 487 mm
Top shelf, 16 mm thick, w × d: 2404 × 487 mm | 1 × LFSSET30 | LED-Folgeset
LED follow-up set |
| 2 × BU 60-58 | Badezimmer-Unterschrank, 1 Tür, 1 Einlegeboden, B × H × T: 600 × 576 × 461 mm
Bathroom base unit, 1 door, 1 shelf, w × h × d: 600 × 576 × 461 mm | | |

WSET06

Seite 30-31
page 30-31

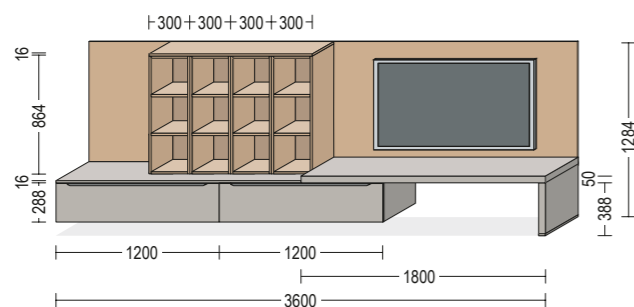

- | | | | |
|----------------|--|--------------|--|
| 2 × BUA 120-29 | Badezimmer-Auszugschrank, 1 Auszug, B × H × T: 1200 × 288 × 461 mm
Bathroom pull-out unit, 1 pull-out, w × h × d: 1200 × 288 × 461 mm | 1 × ADB16 38 | Abdeckboden, 16 mm stark, B × T: 1204 × 373 mm
Top shelf, 16 mm thick, w × d: 1204 × 373 mm |
| 1 × ADB16 49 | Abdeckboden, 16 mm stark, B × T: 1802 × 487 mm
Top shelf, 16 mm thick, w × d: 1802 × 487 mm | 1 × ADB50 49 | Abdeckboden, 50 mm stark, B × T: 1800 × 487 mm
Top shelf, 50 mm thick, w × d: 1800 × 487 mm |
| 1 × NV203 | Nischenwandverkleidung, 16 mm stark, B × H: 602 × 864 mm
Niche cladding, 16 mm thick, w × h: 602 × 864 mm | 1 × UWA 50 | Abschlusswange inkl. Bodenprofil, 50 mm stark, H × T: 388 × 485 mm
Upright at end of run incl. floor seal, 50 mm thick, h × d: 388 × 485 mm |
| 4 × WR 30-3 | Wandregal, 2 feste Böden, B × H × T: 300 × 864 × 371 mm
Open shelf wall unit, 2 fixed shelves, w × h × d: 300 × 864 × 371 mm | 1 × NV203 | Nischenwandverkleidung, 16 mm stark, B × H: 1800 × 830 mm
Niche cladding, 16 mm thick, w × h: 1800 × 830 mm |

Wohngefühl Living atmosphere

WSET07

Seite 56-57
page 56-57

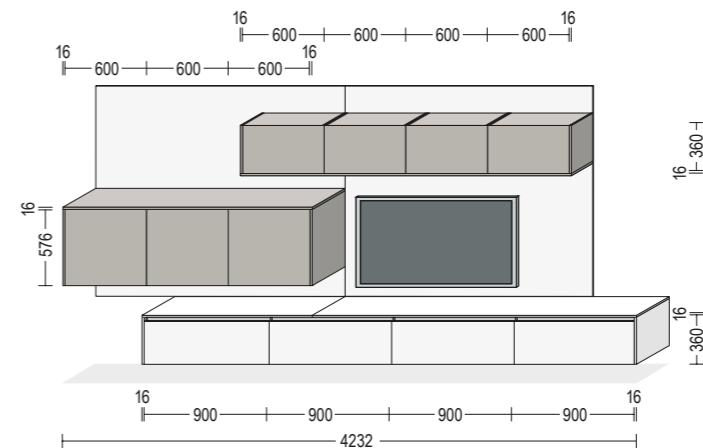

- | | | | |
|----------------|---|--------------|---|
| 4 × NBUA 90-36 | Badezimmer-Auszugschrank, 1 Auszug, B × H × T: 900 × 360 × 461 mm
Bathroom pull-out unit, 1 pull-out, w × h × d: 900 × 360 × 461 mm | 2 × NV203 | Nischenwandverkleidung, 16 mm stark, B × H: 1816 × 1567 mm
Niche cladding, 16 mm thick, w × h: 1816 × 1567 mm |
| 1 × APSLN60 | Arbeitsplatte APSLN Slim Line, 16 mm stark, B × T: 1218 × 484 mm
Slim Line Worktop APSLN, 16 mm thick, w × d: 1218 × 484 mm | 4 × W 60-36 | Wandschrank, 1 Tür, B × H × T: 600 × 360 × 350 mm
Wall unit, 1 door, w × h × d: 600 × 360 × 350 mm |
| 1 × APSLN60 | Arbeitsplatte APSLN Slim Line, 16 mm stark, B × T: 2418 × 484 mm
Slim Line Worktop APSLN, 16 mm thick, w × d: 2418 × 484 mm | 1 × ADB16 38 | Abdeckboden, 16 mm stark, B × T: 2434 × 376 mm
Top shelf, 16 mm thick, w × d: 2434 × 376 mm |
| 2 × NBUW 16-36 | LINE N-Abschlusswange, 16 mm stark, H × T: 360 × 482 mm
LINE N upright at end of run, 16 mm thick, h × d: 360 × 482 mm | 2 × WW 16-36 | Abschluss- / Zwischenwange, 16 mm stark, H × T: Sondermaß 360 × 374 mm
Upright at end of run / intermediate upright, 16 mm thick, h × d: special size 360 × 374 mm |
| 3 × BU 60-58 | Badezimmer-Unterschrank, 1 Tür, 1 Einlegeboden, B × H × T: 600 × 576 × 461 mm
Bathroom base unit, 1 door, 1 shelf, w × h × d: 600 × 576 × 461 mm | 2 × PTO5 | Mechanische Öffnungsunterstützung
Mechanical opening support mechanism |
| 1 × ADB16 49 | Abdeckboden, 16 mm stark, B × T: 1834 × 487 mm
Top shelf, 16 mm thick, w × d: 1834 × 487 mm | | |
| 2 × BUW 16-58 | Abschlusswange, 16 mm stark, H × T: 576 × 485 mm
Upright at end of run, 16 mm thick, h × d: 576 × 485 mm | | |

WSET08

Seite 40-43
page 40-43

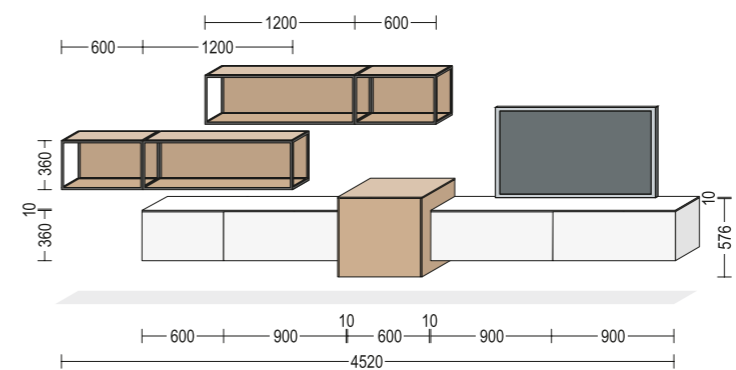

- | | | | |
|---------------|---|-----------------|--|
| 1 × WKB 60-36 | Wandschrank mit Barklappe, 1 Klappe, B × H × T: 600 × 360 × 350 mm
Wall unit with bar flap, 1 flap, w × h × d: 600 × 360 × 350 mm | 2 × WRSC 60-36 | Wandregal Smartcube, B × H × T: 600 × 360 × 250 mm
Open shelf wall unit Smartcube, w × h × d: 600 × 360 × 250 mm |
| 3 × WKB 90-36 | Wandschrank mit Barklappe, 1 Klappe, B × H × T: 900 × 360 × 350 mm
Wall unit with bar flap, 1 flap, w × h × d: 900 × 360 × 350 mm | 2 × RKSC 60-36 | Rückwandverkleidung Smartcube, 16 mm stark, B × H: 563 × 323 mm
Back panel cladding Smartcube, 16 mm thick, w × h: 563 × 323 mm |
| 1 × ADB10 38 | Abdeckboden, 10 mm stark, B × T: 1502 × 376 mm
Top shelf, 10 mm thick, w × d: 1502 × 376 mm | 2 × WRSC 120-36 | Wandregal Smartcube, B × H × T: 1200 × 360 × 250 mm
Open shelf wall unit Smartcube, w × h × d: 1200 × 360 × 250 mm |
| 1 × BU 60-58 | Badezimmer-Unterschrank, 1 Tür, 1 Einlegeboden, B × H × T: 600 × 576 × 461 mm
Bathroom base unit, 1 door, 1 shelf, w × h × d: 600 × 576 × 461 mm | 2 × RKSC 120-36 | Rückwandverkleidung Smartcube, 16 mm stark, B × H: 1163 × 323 mm
Back panel cladding Smartcube, 16 mm thick, w × h: 1163 × 323 mm |
| 1 × ADB10 49 | Abdeckboden, 10 mm stark, B × T: 624 × 487 mm
Top shelf, 10 mm thick, w × d: 624 × 487 mm | 1 × PTO5 | Mechanische Öffnungsunterstützung
Mechanical opening support mechanism |
| 1 × ADB10 38 | Abdeckboden, 10 mm stark, B × T: 1802 × 376 mm
Top shelf, 10 mm thick, w × d: 1802 × 376 mm | 2 × BUW 10-58 | Abschlusswange, 10 mm stark, H × T: 576 × 485 mm
Upright at end of run, 10 mm thick, h × d: 576 × 485 mm |

Spezifikationen Specifications

Die Planungsvorschläge enthalten keine Leuchten, Griffleisten-Mehrpriese oder Steckdosen. Diese müssen zusätzlich zur Set-Artikelnummer bestellt werden. Sondermaße gegen Mehrpreis. TV-Geräte und Dekorationsartikel sind nicht enthalten.
The design suggestions do not contain any lights, bar handle surcharges or sockets. These must be ordered in addition to the set item number. Special dimensions for a surcharge. TVs and decorative items are not included.

Wohngefühl Living atmosphere

WSET09

Seite 32-33
page 32-33

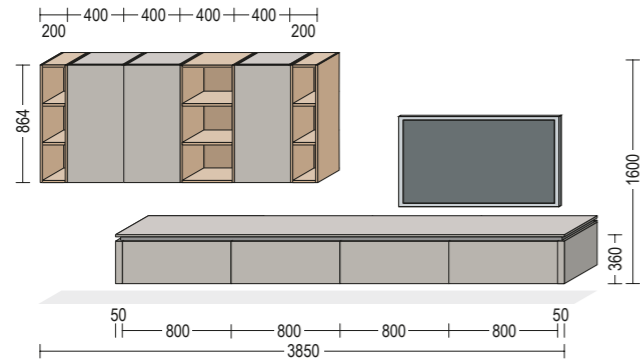

- | | | | |
|----------------|--|-------------|--|
| 4 × NBUA 80-36 | Badezimmer-Auszugschrank, 1 Auszug, B × H × T: 800 × 360 × 461 mm
Bathroom pull-out unit, 1 pull-out, w × h × d: 800 × 360 × 461 mm | 2 × WR 20-3 | Wandregal, 2 feste Böden, B × H × T: 200 × 864 × 371 mm
Open shelf wall unit, 2 fixed shelves, w × h × d: 200 × 864 × 371 mm |
| 1 × APSLN60 | Arbeitsplatte APSLN Slim Line, 16 mm stark, B × T: 3304 × 485 mm
Slime Line Worktop APSLN, 16 mm thick, w × d: 3304 × 485 mm | 3 × NW 40-3 | Wandschrank, 1 Tür, 2 Einlegeböden, B × H × T: 400 × 864 × 350 mm
Wall unit, 1 door, 2 shelves, w × h × d: 400 × 864 × 350 mm |
| 2 × NUWF36 50 | Abschluss-Frontwange, B × H × T: 50 × 360 × Sondermaß 482 mm
Front at end of run upright, w × h × d: 50 × 360 × special size 482 mm | 1 × WR 40-3 | Wandregal, 2 feste Böden, B × H × T: 400 × 864 × 371 mm
Open shelf wall unit, 2 fixed shelves, w × h × d: 400 × 864 × 371 mm |

WSET10

Seite 50-51
page 50-51

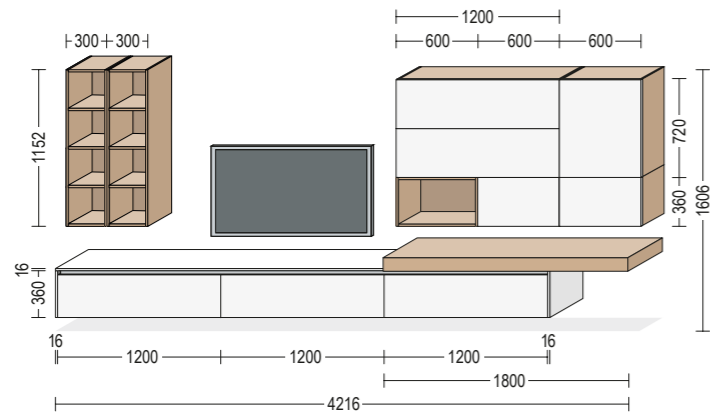

- | | | | |
|-----------------|--|---------------|--|
| 3 × NBUA 120-36 | Badezimmer-Auszugschrank, 1 Auszug, B × H × T: 1200 × 360 × 461 mm
Bathroom pull-out unit, 1 pull-out, w × h × d: 1200 × 360 × 461 mm | 2 × WKB 60-36 | Wandschrank mit Barklappe, 1 Klappe, B × H × T: 600 × 360 × 350 mm
Wall unit with bar flap, 1 flap, w × h × d: 600 × 360 × 350 mm |
| 1 × ADB16 49 | Abdeckboden, 16 mm stark, B × T: 2418 × 484 mm
Top shelf, 16 mm thick, w × d: 2418 × 484 mm | 1 × WFL 120-1 | Wandschrank falt-Lifftür, 1 falt-Lifftür, 2 Originalfronten, 2 Einlegeböden, B × H × T: 1200 × 720 × 350 mm
Wall unit with folding/lifting door, 1 folding/lifting door, 2 original fronts, 2 shelves, w × h × d: 1200 × 720 × 350 mm |
| 2 × NBUW 16-36 | LINE N-Abschlusswange, 16 mm stark, H × T: 360 × 482 mm
LINE N upright at end of run, 16 mm thick, h × d: 360 × 482 mm | 1 × MP-SD | Mehrpriese Servo-Drive
Surcharge for servo motor |
| 1 × APP | Pultplatte, 100 mm stark, B × T: 1800 × 500 mm
Console panel, 100 mm thick, w × d: 1800 × 500 mm | 1 × W 60-1 | Wandschrank, 1 Tür, 2 Einlegeböden, B × H × T: 600 × 720 × 350 mm
Wall unit, 1 door, 2 shelves, w × h × d: 600 × 720 × 350 mm |
| 2 × BMR 30-115 | Badezimmer-Midiregal, 3 feste Böden, B × H × T: 300 × 1152 × 371 mm
Bathroom Midi shelf unit, 3 fixed shelves, w × h × d: 300 × 1152 × 371 mm | 1 × PTOS | Mechanische Öffnungsunterstützung
Mechanical opening support mechanism |
| 1 × WR 60-36 | Wandregal, B × H × T: 600 × 360 × 371 mm
Open shelf wall unit, w × h × d: 600 × 360 × 371 mm | | |

Wohngefühl Living atmosphere

WSET11

Seite 36-37
page 36-37

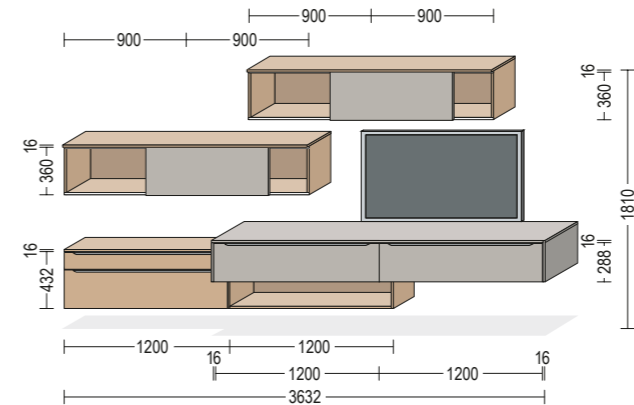

- | | | | |
|-----------------|--|----------------|---|
| 1 × BUSA 120-43 | Badezimmer-Auszugschrank, 1 Schubkasten, 1 Auszug, B × H × T: 1200 × 432 × Sondermaß 350 mm
Bathroom pull-out unit, 1 drawer, 1 pull-out, w × h × d: 1200 × 432 × special size 350 mm | 2 × BUW 16-29 | Abschlusswange, 16 mm stark, H × T: 288 × 485 mm
Upright at end of run, 16 mm thick, h × d: 288 × 485 mm |
| 1 × ADB16 38 | Abdeckboden, 16 mm stark, B × T: 1202 × 376 mm
Top shelf, 16 mm thick, w × d: 1202 × 376 mm | 4 × WSTK 90-36 | Wandschrank für Schiebetüren, B × H × T: 900 × 360 × 350 mm
Wall unit for sliding doors, w × h × d: 900 × 360 × 350 mm |
| 1 × WR 120-36 | Wandregal, B × H × T: 1200 × Sondermaß 288 × 371 mm
Open shelf wall unit, w × h × d: 1200 × special size 288 × 371 mm | 2 × WSTT 90-36 | Schiebetür, B × H: 900 × 357 mm
Sliding door, w × h: 900 × 357 mm |
| 2 × BUA 120-29 | Badezimmer-Auszugschrank, 1 Auszug, B × H × T: 1200 × 288 × 461 mm
Bathroom pull-out unit, 1 pull-out, w × h × d: 1200 × 288 × 461 mm | 2 × WSTP 250 | Laufprofil-Set für Schiebetüren, B × H × T: 1800 × 16 × 8 mm
Runner profile set for sliding doors, w × h × d: 1800 × 16 × 8 mm |
| 1 × ADB16 49 | Abdeckboden, 16 mm stark, B × T: 2436 × 487 mm
Top shelf, 16 mm thick, w × d: 2436 × 487 mm | 2 × ADB16 39 | Abdeckboden, 16 mm stark, B × T: 1804 × 383,5 mm
Top shelf, 16 mm thick, w × d: 1804 × 383.5 mm |

WSET12

Seite 46-49
page 46-49

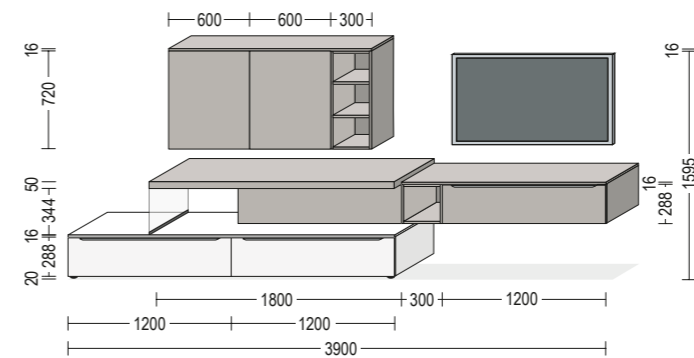

- | | | | |
|----------------|--|---------------|--|
| 2 × UA 120-29 | Auszugschrank / Kochstellenschrank, 1 Auszug, B × H × T: 1200 × 288 × 561 mm
Pull-out unit/hot plate unit, 1 pull-out, w × h × d: 1200 × 288 × 561 mm | 1 × BUR 30-29 | Badezimmer-Unterschrankregal, B × H × T: 300 × 288 × 482 mm
Bathroom open shelf base unit, w × h × d: 300 × 288 × 482 mm |
| 2 × MP-SOWR | Sockelfuß-Set mit 5 Sockelfüßen, Durchmesser 50 mm, H: 20 mm
Plinth foot set with 5 plinth feet, diameter 50 mm, h: 20 mm | 1 × ADB16 49 | Abdeckboden, 16 mm stark, B × T: 1502 × 487 mm
Top shelf, 16 mm thick, w × d: 1502 × 487 mm |
| 1 × ADB16 59 | Abdeckboden, 16 mm stark, B × T: 2404 × 587 mm
Top shelf, 16 mm thick, w × d: 2404 × 587 mm | 2 × W 60-1 | Wandschrank, 1 Tür, 2 Einlegeböden, B × H × T: 600 × 720 × 350 mm
Wall unit, 1 door, 2 shelves, w × h × d: 600 × 720 × 350 mm |
| 1 × UWG 34 | Glaswange, 8 mm stark, H × T: 344 × 585 mm
Glass upright panel, 8 mm thick, h × d: 344 × 585 mm | 1 × WR 30-1 | Wandregal, 2 feste Böden, B × H × T: 300 × 720 × 371 mm
Open shelf wall unit, 2 fixed shelves, w × h × d: 300 × 720 × 371 mm |
| 1 × ADB50 59 | Abdeckboden, 50 mm stark, B × T: 1800 × 587 mm
Top shelf, 50 mm thick, w × d: 1800 × 587 mm | 1 × ADB16 38 | Abdeckboden, 16 mm stark, B × T: 1504 × 376 mm
Top shelf, 16 mm thick, w × d: 1504 × 376 mm |
| 2 × BUA 120-29 | Badezimmer-Auszugschrank, 1 Auszug, B × H × T: 1200 × 288 × 461 mm
Bathroom pull-out unit, 1 pull-out, w × h × d: 1200 × 288 × 461 mm | 1 × PTOS | Mechanische Öffnungsunterstützung
Mechanical opening support mechanism |

SPZIFIKATIONEN SPECIFICATIONS

Die Planungsvorschläge enthalten keine Leuchten, Griffleisten-Mehrpreise oder Steckdosen. Diese müssen zusätzlich zur Set-Artikelnnummer bestellt werden. Sondermaße gegen Mehrpreis. TV-Geräte und Dekorationsartikel sind nicht enthalten.
The design suggestions do not contain any lights, bar handle surcharges or sockets. These must be ordered in addition to the set item number. Special dimensions for a surcharge. TVs and decorative items are not included.

Wohngefühl Living atmosphere

WSET13

Seite 44-45
page 44-45

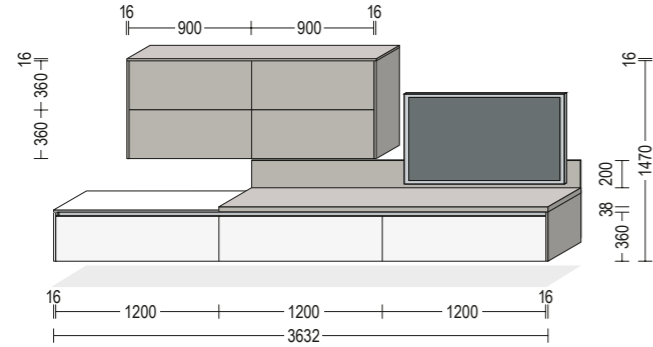

- 3 × NBUA 120-36 **Badezimmer-Auszugschrank, 1 Auszug, B × H × T: 1200 × 360 × 461 mm**
Bathroom pull-out unit, 1 pull-out, w × h × d: 1200 × 360 × 461 mm
- 1 × ADB16 49 **Abdeckboden, 16 mm stark, B × T: 1218 × 484 mm**
Top shelf, 16 mm thick, w × d: 1218 × 484 mm
- 1 × APD60 **Arbeitsplatte APD, 38 mm stark, B × T: 2418 × 484 mm**
Worktop APD, 38 mm thick, w × d: 2418 × 484 mm
- 1 × NV203 **Nischenwandverkleidung, 16 mm stark, B × H: 2418 × 200 mm**
Niche cladding, 16 mm thick, w × h: 2418 × 200 mm

- 2 × NBUW 16-36 **LINE N-Abschlusswange, 16 mm stark, H × T: 360 × 482 mm**
LINE N upright at end of run, 16 mm thick, h × d: 360 × 482 mm
- 4 × WKB 90-36 **Wandschrank mit Barklappe, 1 Klappe, B × H × T: 900 × 360 × 350 mm**
Wall unit with bar flap, 1 flap, w × h × d: 900 × 360 × 350 mm
- 1 × ADB16 38 **Abdeckboden, 16 mm stark, B × T: 1836 × 376 mm**
Top shelf, 16 mm thick, w × d: 1836 × 376 mm
- 2 × WW 16-1 **Abschluss- / Zwischenwange, 16 mm stark, H × T: 720 × 374 mm**
Upright at end of run / intermediate upright, 16 mm thick, h × d: 720 × 374 mm

WSET14

Seite 20-21
page 20-21

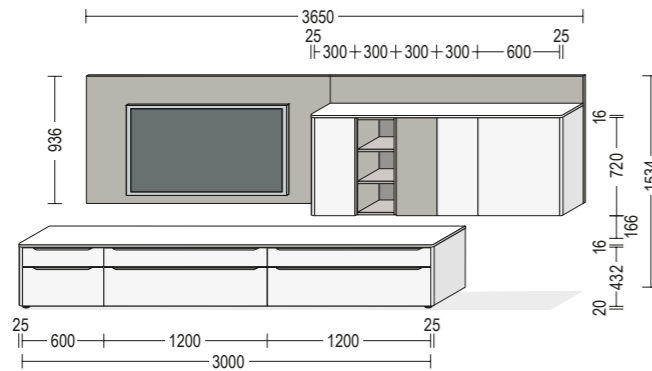

- 2 × WAR 25-43 **Runde Abschlusswange, 25 mm stark, H × T: 432 × 482 mm**
Rounded end upright panel, 25 mm thick, h × d: 432 × 482 mm
- 1 × BUSA 60-43 **Badezimmer-Auszugschrank, 1 Schubkasten, 1 Auszug, B × H × T: 600 × 432 × 461 mm**
Bathroom pull-out unit, 1 drawer, 1 pull-out, w × h × d: 600 × 432 × 461 mm
- 2 × BUSA 120-43 **Badezimmer-Auszugschrank, 1 Schubkasten, 1 Auszug, B × H × T: 1200 × 432 × 461 mm**
Bathroom pull-out unit, 1 drawer, 1 pull-out, w × h × d: 1200 × 432 × 461 mm
- 3 × W 30-1 **Wandschrank, 1 Tür, 2 Einlegeböden, B × H × T: 300 × 720 × 350 mm**
Wall unit, 1 door, 2 shelves, w × h × d: 300 × 720 × 350 mm
- 1 × WR 30-1 **Wandregal, B × H × T: 300 × 720 × 371 mm**
Open shelf wall unit, w × h × d: 300 × 720 × 371 mm
- 1 × W 60-1 **Wandschrank, 1 Tür, 2 Einlegeböden, B × H × T: 600 × 720 × 350 mm**
Wall unit, 1 door, 2 shelves, w × h × d: 600 × 720 × 350 mm

- 2 × WAR 25-72 **Runde Abschlusswange, 25 mm stark, H × T: 720 × 371 mm**
Rounded end upright panel, 25 mm thick, h × d: 720 × 371 mm
- 1 × NV203 **Nischenwandverkleidung, 16 mm stark, B × H: 1800 × 936 mm**
Niche cladding, 16 mm thick, w × h: 1800 × 936 mm
- 1 × NV203 **Nischenwandverkleidung, 16 mm stark, B × H: 1850 × 200 mm**
Niche cladding, 16 mm thick, w × h: 1850 × 200 mm
- 1 × ADB16 38 **Abdeckboden, 16 mm stark, B × T: 1850 × 372,5 mm**
Top shelf, 16 mm thick, w × d: 1850 × 372.5 mm
- 1 × ADB16 59 **Abdeckboden, 16 mm stark, B × T: 2427 × 483,5 mm, Außenradius 22,5 mm ohne MP**
Top shelf, 16 mm thick, w × d: 2427 × 483.5 mm, outer radius 22.5 mm at no surcharge
- 1 × ADB16 59 **Abdeckboden, 16 mm stark, B × T: 627 × 483,5 mm**
Top shelf, 16 mm thick, w × d: 627 × 483.5 mm
- 2 × MP-SOWR **Sockelfuß-Set mit 5 Sockelfüßen, Durchmesser 50 mm, H: 20 mm**
Plinth foot set with 5 plinth feet, diameter 50 mm, h: 20 mm

Wohngefühl Living atmosphere

WSET15

Seite 38-39
page 38-39

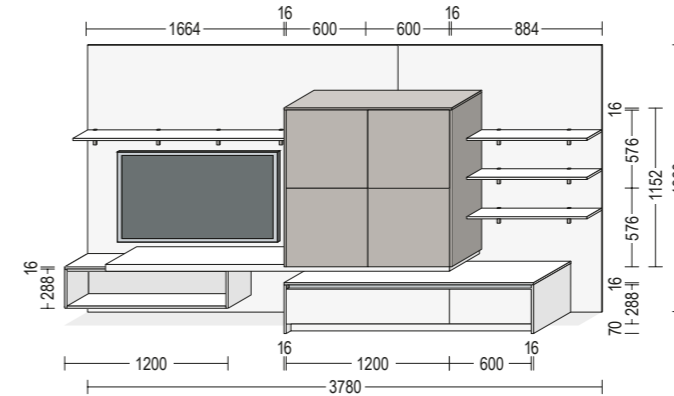

- 1 × WR 120-36 **Wandregal, B × H × T: 1200 × Sondermaß 288 × 371 mm**
Open shelf wall unit, w × h × d: 1200 × special size 288 × 371 mm
- 1 × ADB16 38 **Abdeckboden, 16 mm stark, B × T: 300 × 376 mm**
Top shelf, 16 mm thick, w × d: 300 × 376 mm
- 1 × NV203 **Nischenwandverkleidung, 16 mm stark, B × H: 2280 × 1960 mm**
Niche cladding, 16 mm thick, w × h: 2280 × 1960 mm
- 1 × VB16 258 **Wandbord, 16 mm stark, B × T: 1664 × 255 mm**
Wall shelf unit, 16 mm thick, w × d: 1664 × 255 mm
- 1 × ADB50 49 **Abdeckboden, 50 mm stark, B × T: 2580 × 461 mm**
Top shelf, 50 mm thick, w × d: 2580 × 461 mm
- 1 × UA 120-29 **Auszugsschrank / Kochstellenschrank, 1 Auszug, B × H × T: 1200 × 288 × 561 mm**
Pull-out unit / hot plate unit, 1 pull-out, w × h × d: 1200 × 288 × 561 mm
- 2 × MP-PSO **Mehrpreis-Sockel**
Surcharge for plinth
- 1 × UA 60-29 **Auszugsschrank / Kochstellenschrank, 1 Auszug, B × H × T: 600 × 288 × 561 mm**
Pull-out unit / hot plate unit, 1 pull-out, w × h × d: 600 × 288 × 561 mm
- 1 × ADB16 59 **Abdeckboden, 16 mm stark, B × T: 1836 × 587 mm**
Top shelf, 16 mm thick, w × d: 1836 × 587 mm

- 2 × UWA16 **Abschlusswange inkl. Bodenprofil, 16 mm stark, H × T: 358 × 585 mm**
Upright at end of run incl. floor seal, 16 mm thick, h × d: 358 × 585 mm
- 4 × UFK 60-58 **Überbauschränk, 1 Tür, 1 Einlegeboden, B × H × T: 600 × 576 × Sondermaß 461 mm**
Dresser unit, 1 door, 1 shelf, w × h × d: 600 × 576 × special size 461 mm
- 4 × MP-TK **Mehrpreis Tiefenkürzung für Schränke**
Surcharge for depth reduction on units
- 1 × ADB16 49 **Abdeckboden, 16 mm stark, B × T: 1236 × 487 mm**
Top shelf, 16 mm thick, w × d: 1236 × 487 mm
- 2 × HWK 16 **Abschlusswange, 16 mm stark, H × T: Sondermaß 1152 × Sondermaß 485 mm**
Upright at end of run, 16 mm thick, h × d: special size 1152 × special size 485 mm
- 1 × NV203 **Nischenwandverkleidung, 16 mm stark, B × H: 1500 × 1960 mm**
Niche cladding, 16 mm thick, w × h: 1500 × 1960 mm
- 3 × VB16 100 **Wandbord, 16 mm stark, B × T: 884 × 255 mm**
Wall shelf unit, 16 mm thick, w × d: 884 × 255 mm
- 1 × PTO5 **Mechanische Öffnungsunterstützung**
Mechanical opening support mechanism

WSET16

Seite 52-53
page 52-53

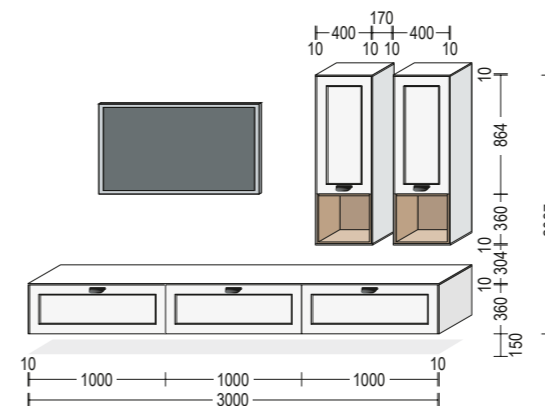

- 2 × BUW 10-36 **Abschlusswange, 10 mm stark, H × T: 360 × 485 mm**
Upright at end of run, 10 mm thick, h × d: 360 × 485 mm
- 3 × BUA 100-36 **Badezimmer-Auszugschrank, 1 Auszug, B × H × T: 1000 × 360 × 461 mm**
Bathroom pull-out unit, 1 pull-out, w × h × d: 1000 × 360 × 461 mm
- 1 × ADB10 59 **Abdeckboden, 10 mm stark, B × T: 2012 × 487 mm**
Top shelf, 10 mm thick, w × d: 2012 × 487 mm
- 1 × ADB10 59 **Abdeckboden, 10 mm stark, B × T: 1012 × 487 mm**
Top shelf, 10 mm thick, w × d: 1012 × 487 mm

- 4 × AW 10-1 **Abschlusswange, 10 mm stark, H × T: 1227 × 374 mm**
Upright at end of run, 10 mm thick, h × d: 1227 × 374 mm
- 2 × W 40-3 **Wandschrank, 1 Tür, 2 Einlegeböden, B × H × T: 400 × 864 × 350 mm**
Wall unit, 1 door, 2 shelves, w × h × d: 400 × 864 × 350 mm
- 2 × WR 40-36 **Wandregal, B × H × T: 400 × 360 × 371 mm**
Open shelf wall unit, w × h × d: 400 × 360 × 371 mm
- 4 × ADB10 38 **Abdeckboden, 10 mm stark, B × T: 423 × 376 mm**
Top shelf, 10 mm thick, B × T: 423 × 376 mm

Spezifikationen Specifications

Die Planungsvorschläge enthalten keine Leuchten, Griffleisten-Mehrpreise oder Steckdosen. Diese müssen zusätzlich zur Set-Artikelnummer bestellt werden. Sondermaße gegen Mehrpreis. TV-Geräte und Dekorationsartikel sind nicht enthalten.
 The design suggestions do not contain any lights, bar handle surcharges or sockets. These must be ordered in addition to the set item number. Special dimensions for a surcharge. TVs and decorative items are not included.

Wohngefühl Living atmosphere

WSET17

Seite 26-29
page 26-29

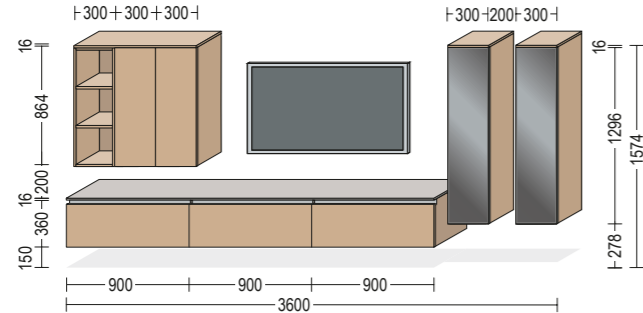

- 1 × WR 30-3 Wandregal, B × H × T: 300 × 864 × 371 mm
Open shelf wall unit, w × h × d: 300 × 864 × 371 mm
- 2 × W 30-3 Wandschrank, 1 Tür, 2 Einlegeböden, B × H × T: 300 × 864 × 350 mm
Wall unit, 1 door, 2 shelves, w × h × d: 300 × 864 × 350 mm
- 2 × WF 30-130 Glas-Wandschrank Flat, 1 Alu-Rahmentür, 2 Glaseinlegeböden, B × H × T: 300 × 1296 × 350 mm
Wall unit with glass doors Flat, 1 aluminium framed door, 2 glass shelves, w × h × d: 300 × 1296 × 350 mm
- 3 × NBUA 90-36 Badezimmer-Auszugschrank, 1 Auszug, B × H × T: 900 × 360 × 461 mm
Bathroom pull-out unit, 1 pull-out, w × h × d: 900 × 360 × 461 mm
- 1 × ADB16 38 Abdeckboden, 16 mm stark, B × T: 903 × 374 mm
Top shelf, 16 mm thick, w × d: 903 × 374 mm
- 2 × ADB16 38 Abdeckboden, 16 mm stark, B × T: 303 × 374 mm
Top shelf, 16 mm thick, w × d: 303 × 374 mm
- 1 × ADB16 59 Abdeckboden, 16 mm stark, B × T: 1802 × 487 mm
Top shelf, 16 mm thick, w × d: 1802 × 487 mm
- 1 × ADB16 59 Abdeckboden, 16 mm stark, B × T: 902 × 487 mm
Top shelf, 16 mm thick, w × d: 902 × 487 mm

Genussmoment Moments of enjoyment

DINSET01

Seite 66-67
page 66-67

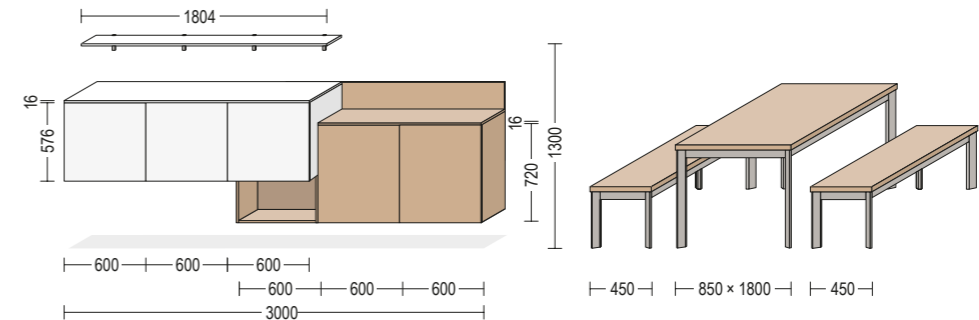

- 3 × BU 60-58 Badezimmer-Unterschrank, 1 Tür, 1 Einlegeboden, B × H × T: 600 × 576 × 461 mm
Bathroom base unit, 1 door, 1 shelf, w × h × d: 600 × 576 × 461 mm
- 1 × WR 60-36 Wandregal, B × H × T: 600 × 360 × 371 mm
Open shelf wall unit, w × h × d: 600 × 360 × 371 mm
- 1 × ADB16 49 Abdeckboden, 16 mm stark, B × T: 1804 × 487 mm
Top shelf, 16 mm thick, w × d: 1804 × 487 mm
- 2 × W 60-1 Wandschrank, 1 Tür, 2 Einlegeböden, B × H × T: 600 × 720 × 350 mm
Wall unit, 1 door, 2 shelves, w × h × d: 600 × 720 × 350 mm
- 1 × ADB16 38 Abdeckboden, 16 mm stark, B × T: 1202 × 376 mm
Top shelf, 16 mm thick, w × d: 1202 × 376 mm
- 1 × NV203 Nischenwandverkleidung, 16 mm stark, B × H: 1202 × 200 mm
Niche cladding, 16 mm thick, w × h: 1202 × 200 mm
- 1 × VB16 258 Wandbord mit Bodenhaltern, 16 mm stark, B × T: 1804 × 255 mm
Wall shelf unit with shelf holders, 16 mm thick, w × d: 1804 × 255 mm

- 1 × PT05 Mechanische Öffnungsunterstützung
Mechanical opening support mechanism
- 2 × ABGF 180 Bankgestell, B × H × T: 1792 × 415 × 442 mm
Bench base, w × h × d: 1792 × 415 × 442 mm
- 2 × APD60 Arbeitsplatte APD mit Dekorkante, 38 mm stark, B × T: 1800 × 450 mm
Worktop APD with décor edge, 38 mm thick, w × d: 1800 × 450 mm
- 1 × ATGF180 Tischgestell, B × H × T: 1792 × 720 × 842 mm
Table frame, w × h × d: 1792 × 720 × 842 mm
- 1 × APD90 Arbeitsplatte APD mit Dekorkante, 38 mm stark, B × T: 1800 × 850 mm
Worktop APD with décor edge, 38 mm thick, w × d: 1800 × 850 mm
- 3 × APD-K Mehrpreis für zusätzliche Kantenbelegung
Surcharge for additional edging

WSET18

Seite 34-35
page 34-35

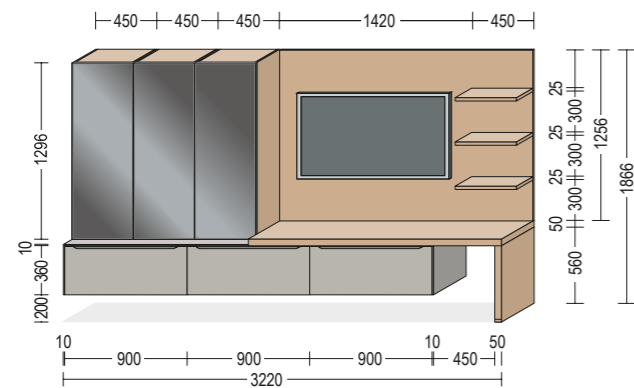

- 3 × WB 25-45 Wand-Steckbord, 25 mm stark, B × T: 450 × 250 mm
Plug-in wall shelf, 25 mm thick, w × d: 450 × 250 mm
- 3 × WF 45-130 Glas-Wandschrank Flat, 1 Alu-Rahmentür, 2 Glaseinlegeböden, B × H × T: 450 × 1296 × 350 mm
Wall unit with glass doors Flat, 1 aluminium framed door, 2 glass shelves, w × h × d: 450 × 1296 × 350 mm
- 1 × NV203 Nischenwandverkleidung, 16 mm stark, B × H: 1870 × 1256 mm
Niche cladding, 16 mm thick, w × h: 1870 × 1256 mm
- 3 × BUA 90-36 Badezimmer-Auszugschrank, 1 Auszug, B × H × T: 900 × 360 × 461 mm
Bathroom pull-out unit, 1 pull-out, w × h × d: 900 × 360 × 461 mm
- 2 × BUW 10-36 Abschlusswange, 10 mm stark, H × T: 360 × 485 mm
Upright at end of run, 10 mm thick, h × d: 360 × 485 mm
- 1 × UWA 50 Abschlusswange, 50 mm stark, H × T: 560 × 485 mm
Upright at end of run, 50 mm thick, h × d: 560 × 485 mm
- 1 × ADB10 59 Abdeckboden, 10 mm stark, B × T: 1352 × 487 mm
Top shelf, 10 mm thick, w × d: 1352 × 487 mm
- 1 × ADB50 59 Abdeckboden, 50 mm stark, B × T: 1870 × 487 mm
Top shelf, 50 mm thick, w × d: 1870 × 487 mm

DINSET02

Seite 58-61
page 58-61

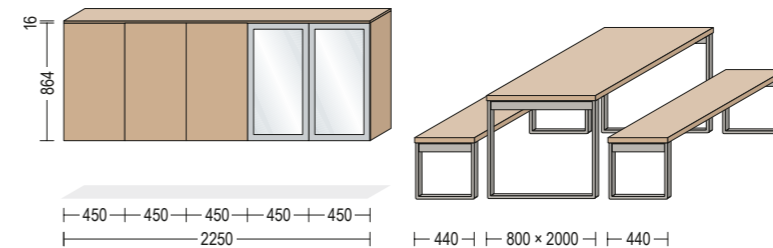

- 3 × W 45-3 Wandschrank, 1 Tür, 2 Einlegeböden, B × H × T: 450 × 864 × 350 mm
Wall unit, 1 door, 2 shelves, w × h × d: 450 × 864 × 350 mm
- 2 × WSQ 45-3 Glas-Wandschrank Square, 1 Alu-Rahmentür, 2 Glaseinlegeböden, B × H × T: 450 × 864 × 350 mm
Wall unit with glass doors Square, 1 aluminium framed door, 2 glass shelves, w × h × d: 450 × 864 × 350 mm
- 1 × ADB16 38 Abdeckboden, 16 mm stark, B × T: 2254 × 376 mm
Top shelf, 16 mm thick, w × d: 2254 × 376 mm
- 1 × PT05 Mechanische Öffnungsunterstützung
Mechanical opening support mechanism

- 2 × ABG Bankgestell, H × T: 415 × 430 mm, 1490 - 2490 mm lang
Bench base, h × d: 415 × 430 mm, 1490 - 2490 mm long
- 2 × APD60 Arbeitsplatte APD mit Dekorkante, 38 mm stark, B × T: 2000 × 440 mm
Worktop APD with décor edge, 38 mm thick, w × d: 2000 × 440 mm
- 1 × ATG-E Tischgestell, H × T: 720 × 790 mm, 1490 - 2490 mm lang
Table frame, h × d: 720 × 790 mm, 1490 - 2490 mm long
- 1 × APD80 Arbeitsplatte APD mit Dekorkante, 38 mm stark, B × T: 2000 × 800 mm
Worktop APD with décor edge, 38 mm thick, w × d: 2000 × 800 mm
- 3 × APD-K Mehrpreis für zusätzliche Kantenbelegung
Surcharge for additional edging

SPZIFIKATIONEN SPECIFICATIONS

Die Planungsvorschläge enthalten keine Leuchten, Griffleisten-Mehrpreise oder Steckdosen. Diese müssen zusätzlich zur Set-Artikelnummer bestellt werden. Sondermaße gegen Mehrpreis. TV-Geräte und Dekorationsartikel sind nicht enthalten.
The design suggestions do not contain any lights, bar handle surcharges or sockets. These must be ordered in addition to the set item number. Special dimensions for a surcharge. TVs and decorative items are not included.

Genussmoment Moments of enjoyment

DINSET03

Seite 64-65
page 64-65

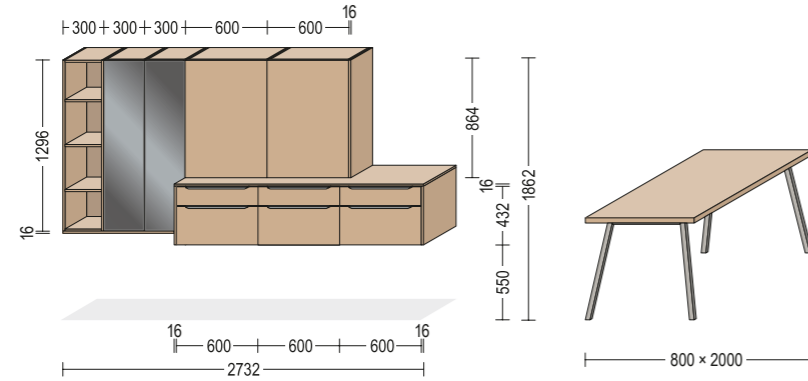

- | | | | |
|----------------|--|--------------|---|
| 1 × WR 30-130 | Wandregal, B × H × T: 300 × 1296 × 371 mm
Open shelf wall unit, w × h × d: 300 × 1296 × 371 mm | 1 × WW 16-3 | Abschluss- / Zwischenwange, 16 mm stark, H × T: 867 × 374 mm
Upright at end of run / intermediate upright, 16 mm thick, h × d: 867 × 374 mm |
| 2 × WF 30-130 | Glas-Wandschrank Flat, 1 Alu-Rahmentür, 2 Glaseinlegeböden, B × H × T: 300 × 1296 × 350 mm
Wall unit with glass doors Flat, 1 aluminium framed door, 2 glass shelves, w × h × d: 300 × 1296 × 350 mm | 1 × ADB16 59 | Abdeckboden, 16 mm stark, B × T: 1834 × 487 mm
Top shelf, 16 mm thick, w × d: 1834 × 487 mm |
| 2 × W 60-3 | Wandschrank, 1 Tür, 2 Einlegeböden, B × H × T: 600 × 864 × 350 mm
Wall unit, 1 door, 2 shelves, w × h × d: 600 × 864 × 350 mm | 1 × ADB16 38 | Abdeckboden, 16 mm stark, B × T: 902 × 376 mm
Top shelf, 16 mm thick, w × d: 902 × 376 mm |
| 1 × PT05 | Mechanische Öffnungsunterstützung
Mechanical opening support mechanism | 1 × ATGT-E | Tischgestell, H × T: 711 × 800 mm, 1400-2000 mm lang
Table frame, h × d: 711 × 800 mm, 1400-2000 mm long |
| 3 × BUSA 60-43 | Badezimmer-Auszugschrank, 1 Schubkasten, 1 Auszug, B × H × T: 600 × 432 × 461 mm
Bathroom pull-out unit, 1 drawer, 1 pull-out, w × h × d: 600 × 432 × 461 mm | 1 × APD80 | Arbeitsplatte APD mit Dekorkante, 38 mm stark, B × T: 2000 × 800 mm
Worktop APD with décor edge, 38 mm thick, w × d: 2000 × 800 mm |
| 2 × BUW 16-43 | Abschlusswange, 16 mm stark, H × T: 432 × 485 mm
Upright at end of run, 16 mm thick, h × d: 432 × 485 mm | 1 × APD-K | Mehrpreis für zusätzliche Kantenbelegung
Surcharge for additional edging |

DINSET04

Seite 62-63
page 62-63

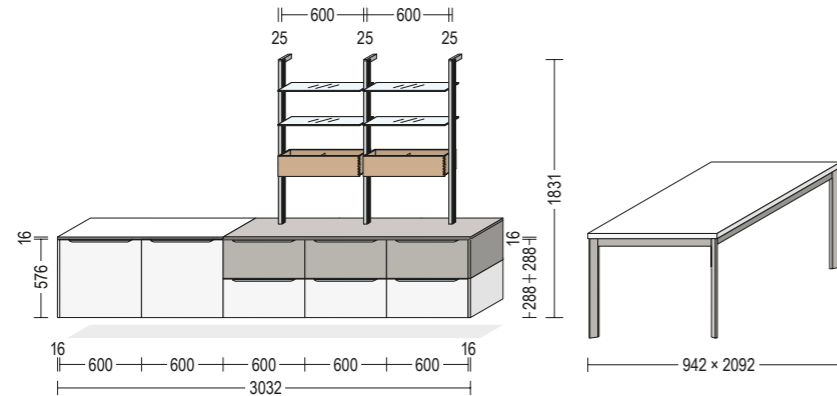

- | | | | |
|---------------|--|----------------|--|
| 2 × BU 60-58 | Badezimmer-Unterschrank, 1 Tür, 1 Einlegeboden, B × H × T: 600 × 576 × 461 mm
Bathroom base unit, 1 door, 1 shelf, w × h × d: 600 × 576 × 461 mm | 4 × RSG 60 | Glasboden, 8 mm stark, B × T: 600 × 220 mm
Glass shelf, 8 mm thick, w × d: 600 × 220 mm |
| 1 × ADB16 49 | Abdeckboden, 16 mm stark, B × T: 1218 × 487 mm
Top shelf, 16 mm thick, w × d: 1218 × 487 mm | 2 × RSHK 60-H | Holzkasten, B × H × T: 600 × 150 × 170 mm
Wooden box, w × h × d: 600 × 150 × 170 mm |
| 1 × BUW 16-58 | Abschlusswange, 16 mm stark, H × T: 576 × 485 mm
Upright at end of run, 16 mm thick, h × d: 576 × 485 mm | 2 × RSKRS 60-H | Kunststoff Kräuterschale, 2 Stück, B × H: 600 × 125 mm
Plastic herb pot, 2 pieces, w × h: 600 × 125 mm |
| 6 × BUA 60-29 | Badezimmer-Auszugschrank, 1 Auszug, B × H × T: 600 × 288 × 461 mm
Bathroom pull-out unit, 1 pull-out, w × h × d: 600 × 288 × 461 mm | 1 × ATGO 210-S | Tischgestell Otello, H × T: 732 × 942 mm, 2092 mm lang
Table frame Otello, h × d: 732 × 942 mm, 2092 mm long |
| 1 × ADB16 49 | Abdeckboden, 16 mm stark, B × T: 1818 × 487 mm
Top shelf, 16 mm thick, w × d: 1818 × 487 mm | 1 × APD100 | Arbeitsplatte APD mit Dekorkante, 38 mm stark, B × T: 2100 × 950 mm
Worktop APD with décor edge, 38 mm thick, w × d: 2100 × 950 mm |
| 2 × BUW 16-29 | Abschlusswange, 16 mm stark, H × T: 288 × 485 mm
Upright at end of run, 16 mm thick, h × d: 288 × 485 mm | 1 × APD-K | Mehrpreis für zusätzliche Kantenbelegung
Surcharge for additional edging |
| 3 × ARS 15-1 | Aluminiumstollen in Aufsatzschrankhöhe 1, T: 150 mm
Aluminium support poles in dresser unit height 1, d: 150 mm | | |

Ordnungsliebe A love of order

GSET01

Seite 68-71
page 68-71

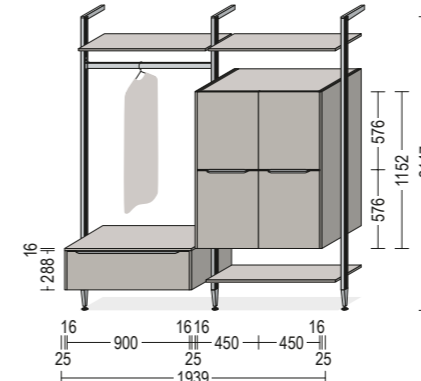

- | | | | |
|---------------|---|-----------------|--|
| 3 × HRS 30-1 | Aluminiumstollen in Hochschrankhöhe 1, T: 295 mm
Aluminium support poles in tall unit height 1, d: 295 mm | 3 × RSB16 90-38 | Regalboden, 16 mm stark, B × T: Sondermaß 932 × 380 mm
Shelf, 16 mm thick, w × d: special size 932 × 380 mm |
| 1 × BUA 90-29 | Badezimmer-Auszugschrank, 1 Auszug, B × H × T: 900 × 288 × 461 mm
Bathroom pull-out unit, 1 pull-out, w × h × d: 900 × 288 × 461 mm | 2 × HWK 16 | Abschlusswange, 16 mm stark, H × T: 1152 × 485 mm
Upright at end of run, 16 mm thick, h × d: 1152 × 485 mm |
| 1 × ADB16 49 | Abdeckboden, 16 mm stark, B × T: 932 × 487 mm
Top shelf, 16 mm thick, w × d: 932 × 487 mm | 4 × BU 45-58 | Badezimmer-Unterschrank, 1 Tür, 1 Einlegeboden, B × H × T: 450 × 576 × 461 mm
Bathroom base unit, 1 door, 1 shelf, w × h × d: 450 × 576 × 461 mm |
| 2 × BUW 16-29 | Abschlusswange, 16 mm stark, H × T: 288 × 485 mm
Upright at end of run, 16 mm thick, h × d: 288 × 485 mm | 2 × RSSK | Schrank-Konnektor
Unit connector |
| 1 × RSKST 93 | Kleiderstange, B: 932 mm
Clothes rail, w: 932 mm | | |

GSET02

Seite 72-73
page 72-73

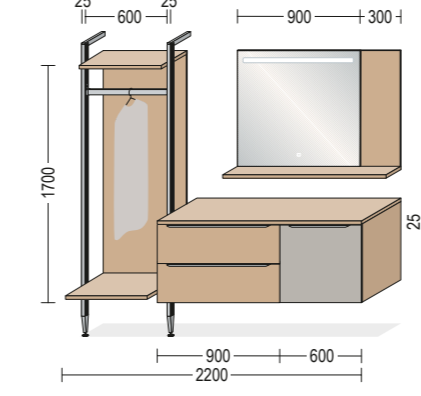

- | | | | |
|-----------------|--|---------------|---|
| 2 × HRS 30-1 | Aluminiumstollen in Hochschrankhöhe 1, T: 295 mm
Aluminium support poles in tall unit height 1, d: 295 mm | 1 × ADB25 49 | Abdeckboden, 25 mm stark, B × T: 1504 × 487 mm
Top shelf, 25 mm thick, w × d: 1504 × 487 mm |
| 2 × RSB25 60-38 | Regalboden, 25 mm stark, B × T: 600 × 380 mm
Shelf, 25 mm thick, w × d: 600 × 380 mm | 1 × WB 25-120 | Wand-Steckbord, 25 mm stark, B × T: 1200 × 255 mm
Plug-in wall shelf, 25 mm thick, w × d: 1200 × 255 mm |
| 1 × RSKST 60 | Kleiderstange, B: 600 mm
Clothes rail, w: 600 mm | 1 × SPLH 90 | Spiegel mit horizontalem LED-Lichtfenster, H × T: 850 × 24 mm
Mirror with horizontal LED light window, h × d: 850 × 24 mm |
| 1 × NV203 | Nischenwandverkleidung, 16 mm stark, B × H: 600 × 1700 mm
Niche cladding, 16 mm thick, w × h: 600 × 1700 mm | 1 × NV203 | Nischenwandverkleidung, 16 mm stark, B × H: 1200 × 850 mm
Niche cladding, 16 mm thick, w × h: 1200 × 850 mm |
| 1 × BU2A 90-58 | Badezimmer-Auszugschrank, 2 Auszüge, B × H × T: 900 × 576 × 461 mm
Bathroom pull-out unit, 2 pull-outs, w × h × d: 900 × 576 × 461 mm | | |
| 1 × BU 60-58 | Badezimmer-Unterschrank, 1 Tür, 1 Einlegeboden, B × H × T: 600 × 576 × 461 mm
Bathroom base unit, 1 door, 1 shelf, w × h × d: 600 × 576 × 461 mm | | |

SPZIFIKATIONEN SPECIFICATIONS

Die Planungsvorschläge enthalten keine Leuchten, Griffleisten-Mehrpreise oder Steckdosen. Diese müssen zusätzlich zur Set-Artikelnnummer bestellt werden. Sondermaße gegen Mehrpreis. TV-Geräte und Dekorationsartikel sind nicht enthalten.
The design suggestions do not contain any lights, bar handle surcharges or sockets. These must be ordered in addition to the set item number. Special dimensions for a surcharge. TVs and decorative items are not included.

Ordnungsliebe A love of order

GSET03

Seite 74-75
page 74-75

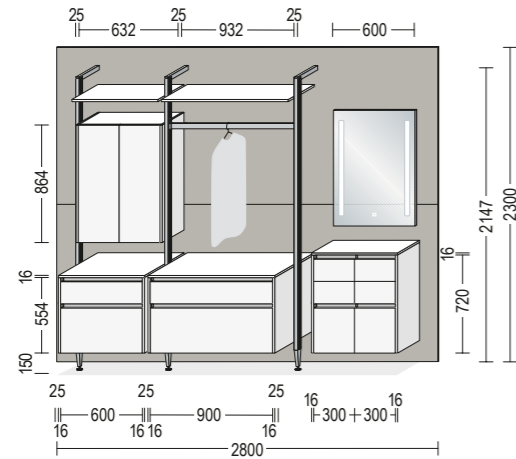

3 × HRS 30-1 Aluminiumstollen in Hochschrankhöhe 1, T: 295 mm
Aluminium support poles in tall unit height 1, d: 295 mm

1 × NBUSA 60-55 Badezimmer-Auszugschrank, 1 Schubkasten, 1 Auszug,
B × H × T: 600 × 554 × 461 mm
Bathroom pull-out unit, 1 drawer, 1 pull-out,
w × h × d: 600 × 554 × 461 mm

1 × ADB16 49 Abdeckboden, 16 mm stark, B × T: 632 × 484 mm
Top shelf, 16 mm thick, w × d: 632 × 484 mm

1 × NBUSA 90-55 Badezimmer-Auszugschrank, 1 Schubkasten, 1 Auszug,
B × H × T: 900 × 554 × 461 mm
Bathroom pull-out unit, 1 drawer, 1 pull-out,
w × h × d: 900 × 554 × 461 mm

1 × ADB16 49 Abdeckboden, 16 mm stark, B × T: 932 × 484 mm
Top shelf, 16 mm thick, w × d: 932 × 484 mm

4 × NBUW 16-55 LINE N-Abschlusswange, 16 mm stark, H × T: 554 × 482 mm
LINE N upright at end of run, 16 mm thick, h × d: 554 × 482 mm

1 × NW2T 60-3 Wandschrank, 2 Türen, 2 Einlegeböden, B × H × T: 600 × 864 × 350 mm
Wall unit, 2 doors, 2 shelves, w × h × d: 600 × 864 × 350 mm

2 × WW 16-3 Abschluss- / Zwischenwange, 16 mm stark, H × T: 864 × 374 mm
Upright at end of run / intermediate upright, 16 mm thick,
h × d: 864 × 374 mm

1 × RSB16 60-38 Regalboden, 16 mm stark, B × T: Sondermaß 632 × Sondermaß 359 mm
Shelf, 16 mm thick, w × d: special size 632 × special size 359 mm

1 × RSKST 93 Kleiderstange, B: 932 mm
Clothes rail, w: 932 mm

1 × RSB16 90-38 Regalboden, 16 mm stark, B × T: Sondermaß 932 × Sondermaß 359 mm
Shelf, 16 mm thick, w × d: special size 932 × special size 359 mm

2 × NBS2SA 30-72 Badezimmer-Sideboard, 2 Schubkästen, 1 Auszug,
B × H × T: 300 × 720 × 350 mm
Bathroom sideboard, 2 drawers, 1 pull-out,
w × h × d: 300 × 720 × 350 mm

1 × ADB16 38 Abdeckboden, 16 mm stark, B × T: 636 × 373 mm
Top shelf, 16 mm thick, w × d: 636 × 373 mm

2 × NBSW 16-72 LINE N-Abschlusswange, 16 mm stark, H × T: 720 × 371 mm
LINE N upright at end of run, 16 mm thick, h × d: 720 × 371 mm

1 × SPLV 60 Spiegel mit vertikalen LED-Lichtfenstern, H × T: 850 × 24 mm
Mirror with vertical LED light windows, h × d: 850 × 24 mm

2 × NVM120 Nischenverkleidung mit Motiv im Digitalprint, 16 mm stark,
B × H: 2800 × 1150 mm
Niche cladding with digitally printed motif, 16 mm thick,
w × h: 2800 × 1150 mm

3 × RSSK Schrank-Konnektor
Unit connector

GSET04

Seite 75
page 75

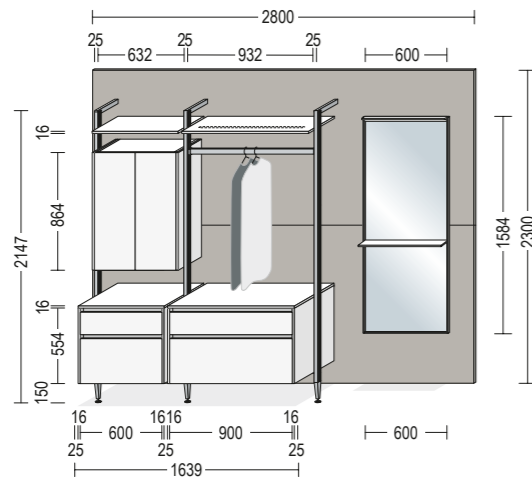

3 × HRS 30-1 Aluminiumstollen in Hochschrankhöhe 1, T: 295 mm
Aluminium support poles in tall unit height 1, d: 295 mm

1 × NBUSA 60-55 Badezimmer-Auszugschrank, 1 Schubkasten, 1 Auszug,
B × H × T: 600 × 554 × 461 mm
Bathroom pull-out unit, 1 drawer, 1 pull-out,
w × h × d: 600 × 554 × 461 mm

1 × ADB16 49 Abdeckboden, 16 mm stark, B × T: 632 × 484 mm
Top shelf, 16 mm thick, w × d: 632 × 484 mm

1 × NBUSA 90-55 Badezimmer-Auszugschrank, 1 Schubkasten, 1 Auszug,
B × H × T: 900 × 554 × 461 mm
Bathroom pull-out unit, 1 drawer, 1 pull-out,
w × h × d: 900 × 554 × 461 mm

Ordnungsliebe A love of order

1 × ADB16 49 Abdeckboden, 16 mm stark, B × T: 932 × 484 mm
Top shelf, 16 mm thick, w × d: 932 × 484 mm

4 × NBUW 16-55 LINE N-Abschlusswange, 16 mm stark, H × T: 554 × 482 mm
LINE N upright at end of run, 16 mm thick, h × d: 554 × 482 mm

1 × NW2T 60-3 Wandschrank, 2 Türen, 2 Einlegeböden, B × H × T: 600 × 864 × 350 mm
Wall unit, 2 doors, 2 shelves, w × h × d: 600 × 864 × 350 mm

2 × WW 16-3 Abschluss- / Zwischenwange, 16 mm stark, H × T: 864 × 374 mm
Upright at end of run / intermediate upright, 16 mm thick,
h × d: 864 × 374 mm

1 × RSB16 60-38 Regalboden, 16 mm stark, B × T: Sondermaß 632 × Sondermaß 359 mm
Shelf, 16 mm thick, w × d: special size 632 × special size 359 mm

1 × RSKST 93 Kleiderstange, B: 932 mm
Clothes rail, w: 932 mm

1 × RSB16 90-38 Regalboden, 16 mm stark, B × T: Sondermaß 932 × Sondermaß 359 mm
Shelf, 16 mm thick, w × d: special size 932 × special size 359 mm

1 × SPLARG 60 Spiegel mit LED-Beleuchtung und Ablagefläche,
B × H × T: 600 × 1584 × 146 mm mit Ablage, 1 Ablagefläche 111 mm,
LED-Beleuchtung oben und unten
Mirror with LED light and storage shelf,
w × h × d: 600 × 1584 × 146 mm with shelf, 1 storage shelf 111 mm,
LED light on top and bottom

2 × NVM120 Nischenverkleidung mit Motiv im Digitalprint, 16 mm stark,
B × H: 2800 × 1150 mm
Niche cladding with digitally printed motif, 16 mm thick,
w × h: 2800 × 1150 mm

3 × RSSK Schrank-Konnektor
Unit connector

Kleidertraum Clothing dreams

DRSET01

Seite 76-79
page 76-79

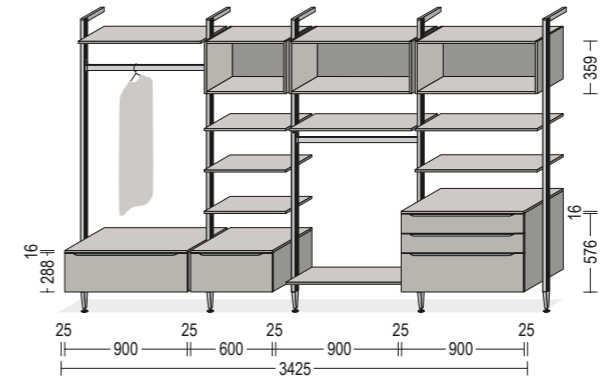

5 × HRS 30-1 Aluminiumstollen in Hochschrankhöhe 1, T: 295 mm
Aluminium support poles in tall unit height 1, d: 295 mm

1 × BUA 90-29 Badezimmer-Auszugschrank, 1 Auszug, B × H × T: 900 × 288 × 461 mm
Bathroom pull-out unit, 1 pull-out, w × h × d: 900 × 288 × 461 mm

2 × ADB16 49 Abdeckboden, 16 mm stark, B × T: 900 × 487 mm
Top shelf, 16 mm thick, w × d: 900 × 487 mm

2 × RSKST 90 Kleiderstange, B: 900 mm
Clothes rail, w: 900 mm

5 × RSB16 90-38 Regalboden, 16 mm stark, B × T: 900 × 380 mm
Shelf, 16 mm thick, w × d: 900 × 380 mm

1 × BUA 60-29 Badezimmer-Auszugschrank, 1 Auszug, B × H × T: 600 × 288 × 461 mm
Bathroom pull-out unit, 1 pull-out, w × h × d: 600 × 288 × 461 mm

1 × ADB16 49 Abdeckboden, 16 mm stark, B × T: 600 × 487 mm
Top shelf, 16 mm thick, w × d: 600 × 487 mm

3 × RSB16 60-38 Regalboden, 16 mm stark, B × T: 600 × 380 mm
Shelf, 16 mm thick, w × d: 600 × 380 mm

1 × WR 60-36 Wandregal, B × H × T: 600 × 360 × 371 mm
Open shelf wall unit, w × h × d: 600 × 360 × 371 mm

2 × WR 90-36 Wandregal, B × H × T: 900 × 360 × 371 mm
Open shelf wall unit, w × h × d: 900 × 360 × 371 mm

1 × BU2SA 90-58 Badezimmer-Auszugschrank, 2 Schubkästen, 1 Auszug,
B × H × T: 900 × 576 × 461 mm
Bathroom pull-out unit, 2 drawers, 1 pull-out,
w × h × d: 900 × 576 × 461 mm

6 × RSSK Schrank-Konnektor
Unit connector

SPZIFIKATIONEN SPECIFICATIONS

Die Planungsvorschläge enthalten keine Leuchten, Griffleisten-Mehrpreise oder Steckdosen. Diese müssen zusätzlich zur Set-Artikelnummer bestellt werden. Sondermaße gegen Mehrpreis. TV-Geräte und Dekorationsartikel sind nicht enthalten.
 The design suggestions do not contain any lights, bar handle surcharges or sockets. These must be ordered in addition to the set item number. Special dimensions for a surcharge. TVs and decorative items are not included.

Kleidertraum Clothing dreams

DRSET02

Seite 80-81
page 80-81

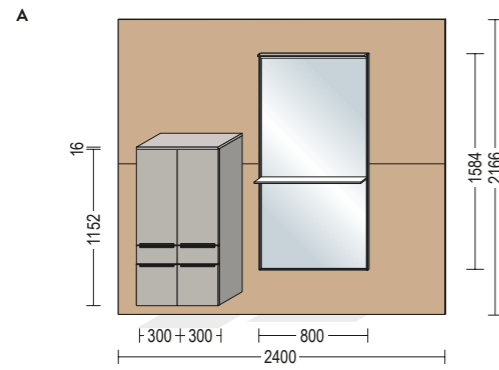
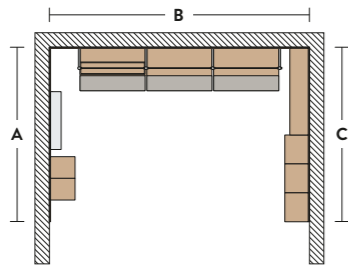

- 1 × NV203 Nischenwandverkleidung, 16 mm stark, B × H: 2400 × 1112 mm
Niche cladding, 16 mm thick, w × h: 2400 × 1112 mm
- 1 × NV203 Nischenwandverkleidung, 16 mm stark, B × H: 2400 × 1054 mm
Niche cladding, 16 mm thick, w × h: 2400 × 1054 mm
- 2 × BMSA 30-115 Badezimmer-Midischrank, 1 Tür, 1 Schubkasten, 1 Auszug, 2 Einlegeböden, B × H × T: 300 × 1152 × 350 mm
Bathroom Midi unit, 1 door, 1 drawer, 1 pull-out, 2 shelves, w × h × d: 300 × 1152 × 350 mm
- 1 × ADB16 38 Abdeckboden, 16 mm stark, B × T: 604 × 376 mm
Top shelf, 16 mm thick, w × d: 604 × 376 mm
- 1 × SPLARG 80 Spiegel mit LED-Beleuchtung und Ablagefläche, B × H × T: 800 × 1584 × 146 mm mit Ablage, 1 Ablagefläche 111 mm, LED-Beleuchtung oben und unten
Mirror with LED light and storage shelf, w × h × d: 800 × 1584 × 146 mm with shelf, 1 storage shelf 111 mm, LED light on top and bottom

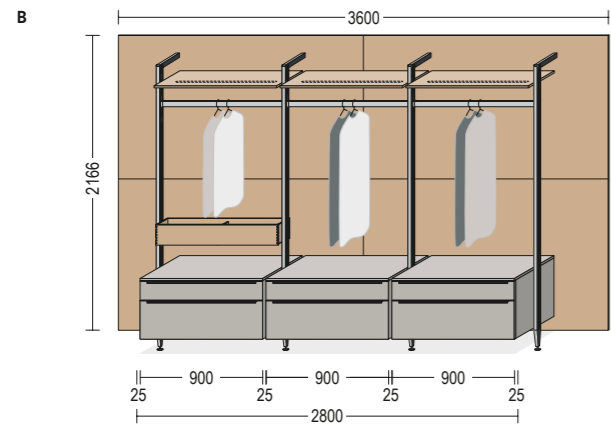



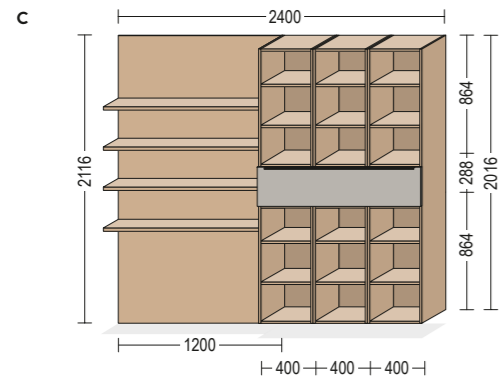



















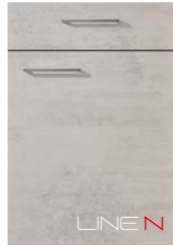

- 2 × NV203 Nischenwandverkleidung, 16 mm stark, B × H: 1800 × 1054 mm
Niche cladding, 16 mm thick, w × h: 1800 × 1054 mm
- 2 × NV203 Nischenwandverkleidung, 16 mm stark, B × H: 1800 × 1112 mm
Niche cladding, 16 mm thick, w × h: 1800 × 1112 mm
- 4 × HRS 30-1 Aluminiumstollen in Hochschrankhöhe 1, T: 295 mm
Aluminium support poles in tall unit height 1, d: 295 mm
- 3 × USARS 90-43 Auszugschrank, 1 Schubkasten, 1 Auszug, B × H: 900 × 432 mm
Pull-out unit, 1 drawer, 1 pull-out, w × h: 900 × 432 mm
- 3 × ADB16 59 Abdeckboden, 16 mm stark, B × T: 900 × 587 mm
Top shelf, 16 mm thick, w × d: 900 × 587 mm
- 3 × RSKST 90 Kleiderstange, B: 900 mm
Clothes rail, w: 900 mm
- 1 × RSHK 90-H Holzkasten, B × H × T: 900 × 150 × 170 mm
Wooden box, w × h × d: 900 × 150 × 170 mm
- 3 × RSB16 90-38 Regalboden, 16 mm stark, B × T: 900 × 380 mm
Shelf, 16 mm thick, w × d: 900 × 380 mm

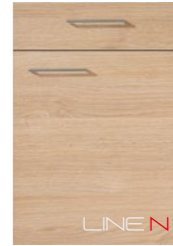

- 1 × NV203 Nischenwandverkleidung, 16 mm stark, B × H: 1200 × 1054 mm
Niche cladding, 16 mm thick, w × h: 1200 × 1054 mm
- 1 × NV203 Nischenwandverkleidung, 16 mm stark, B × H: 1200 × 1112 mm
Niche cladding, 16 mm thick, w × h: 1200 × 1112 mm
- 4 × WB25 120 Wand-Steckbord, 25 mm stark, B × T: 1200 × 255 mm
Plug-in wall shelf, 25 mm thick, w × d: 1200 × 255 mm
- 6 × WR 40-3 Wandregal 2 feste Böden, B × H × T: 400 × 864 × 371 mm
Open shelf wall unit, 2 fixed shelves, w × h × d: 400 × 864 × 371 mm
- 1 × BUA 120-29 Badezimmer-Auszugschrank, 1 Auszug, B × H × T: 1200 × 288 × Sondermaß 350 mm
Bathroom pull-out unit, 1 pull-out, w × h × d: 1200 × 288 × special size 350 mm















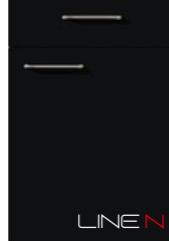



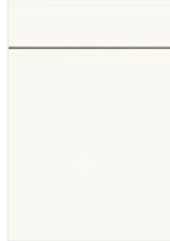



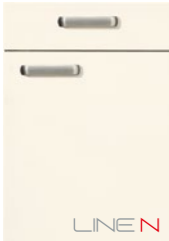





















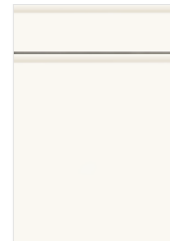

FRONTEN FRONTS

Fronten, die mit dem LINE N-Logo versehen sind, sind auch als grifflose Planungen lieferbar.
 Fronts marked with the LINE N logo are also available as handleless designs.















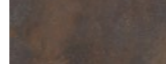

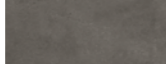

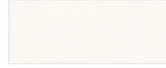











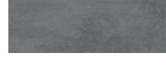

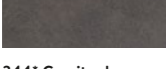

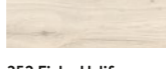
					
SPEED 244 Alpinweiß	SPEED 239 Weiß softmatt	SPEED 206 Magnolia softmatt	SPEED 259 Seidengrau	SPEED 288 Schwarzbeton Nachbildung	SPEED 262 Eiche Virginia Nachbildung
PG 1	PG 1	PG 1	PG 1	PG 1	PG 1
SPEED 244 Alpine white	SPEED 239 White softmatt	SPEED 206 Ivory softmatt	SPEED 259 Satin grey	SPEED 288 Black Concrete reproduction	SPEED 262 Virginia oak reproduction
					
LASER 427 Alpinweiß	LASER 416 Weiß	LASER 418 Magnolia matt	LASER 417 Seidengrau	LASER 415 Sand	RIVA 891 Weißbeton Nachbildung
PG 2	PG 2	PG 2	PG 2	PG 2	PG 2
LASER 427 Alpine white	LASER 416 White	LASER 418 Ivory matt	LASER 417 Satin grey	LASER 415 Sand	RIVA 891 White Concrete reproduction
					
RIVA 892 Beton grau Nachbildung	RIVA 889 Beton schiefergrau Nachbildung	RIVA 839 Beton Terragrau Nachbildung	RIVA 893 Eiche San Remo Nachbildung	RIVA 887 Eiche Somerset Nachbildung	RIVA 840 Nussbaum Nachbildung
PG 2	PG 2	PG 2	PG 2	PG 2	PG 2
RIVA 892 Concrete grey reproduction	RIVA 889 Concrete Slate Grey reproduction	RIVA 839 Concrete Terra grey reproduction	RIVA 893 Sanremo oak reproduction	RIVA 887 Somerset oak reproduction	RIVA 840 Walnut reproduction
					
STRUCTURA 401 Eiche Halifax Nachbildung	STRUCTURA 402 Eiche Havanna Nachbildung	STRUCTURA 405 Eiche Sierra Nachbildung	STRUCTURA 403 Eiche Nero Nachbildung	TOUCH 332 Lacklaminat, Alpinweiß supermatt	TOUCH 336 Lacklaminat, Magnolia supermatt
PG 3	PG 3	PG 3	PG 3	PG 3	PG 3
STRUCTURA 401 Sherwood oak reproduction	STRUCTURA 402 Havana oak reproduction	STRUCTURA 405 Sierra oak reproduction	STRUCTURA 403 Nero oak reproduction	TOUCH 332 Lacquered laminate, alpine white supermatt	TOUCH 336 Lacquered laminate, ivory supermatt

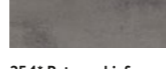
FRONTEN FRONTS

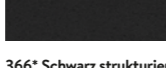
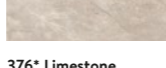
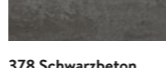

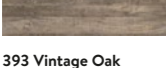
Fronten, die mit dem LINE N-Logo versehen sind, sind auch als grifflose Planungen lieferbar.
 Fronts marked with the LINE N logo are also available as handleless designs.

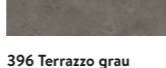
											
TOUCH 338 PG 3 Lacklaminat, Seidengrau supermatt	TOUCH 341 PG 3 Lacklaminat, Steingrau supermatt	TOUCH 337 PG 3 Lacklaminat, Aqua supermatt	TOUCH 334 PG 3 Lacklaminat, Schiefergrau supermatt	TOUCH 340 PG 3 Lacklaminat, Schwarz supermatt	FLASH 503 PG 3 Lacklaminat, Alpinweiß Hochglanz	FOCUS 462 PG 4 Lack, Magnolia Ultra-Hochglanz	FOCUS 467 PG 4 Lack, Sand Ultra-Hochglanz	INLINE 551 PG 5 Lack, Alpinweiß matt	CREDO 764 PG 6 Lacklaminat, Alpinweiß	CASCADA 774 PG 7 Lacklaminat, Weiß	CASCADA 772 PG 7 Lacklaminat, Steingrau
TOUCH 338 PG 3 Lacquered laminate, satin grey supermatt	TOUCH 341 PG 3 Lacquered laminate, stone grey supermatt	TOUCH 337 PG 3 Lacquered laminate, aqua supermatt	TOUCH 334 PG 3 Lacquered laminate, slate grey supermatt	TOUCH 340 PG 3 Lacquered laminate, black supermatt	FLASH 503 PG 3 Lacquered laminate, alpine white high gloss	FOCUS 462 PG 4 Lacquer, ivory ultra high gloss	FOCUS 467 PG 4 Lacquer, sand ultra high gloss	INLINE 551 PG 5 Lacquer, honed alpine white	CREDO 764 PG 6 Lacquered laminate, alpine white	CASCADA 774 PG 7 Lacquered laminate, white	CASCADA 772 PG 7 Lacquered laminate, stone grey
											
FLASH 450 PG 3 Lacklaminat, Weiß Hochglanz	FLASH 452 PG 3 Lacklaminat, Magnolia Hochglanz	FLASH 455 PG 3 Lacklaminat, Seidengrau Hochglanz	FLASH 453 PG 3 Lacklaminat, Schiefergrau Hochglanz	EASYTOUCH 967 PG 4 Lacklaminat, Alpinweiß ultramatt	EASYTOUCH 969 PG 4 Lacklaminat, Sand ultramatt	CASCADA 776 PG 7 Lacklaminat, Schilf	NORDIC 782 PG 7 Lack, Weiß matt	SYLT 847 PG 7 Lack, Alpinweiß matt	SYLT 849 PG 7 Lack, Magnolia matt	SYLT 851 PG 7 Lack, Schwarz matt	CASTELLO 390 PG 8 Lack, Magnolia gewischt
FLASH 450 PG 3 Lacquered laminate, white high gloss	FLASH 452 PG 3 Lacquered laminate, ivory high gloss	FLASH 455 PG 3 Lacquered laminate, satin grey high gloss	FLASH 453 PG 3 Lacquered laminate, slate grey high gloss	EASYTOUCH 967 PG 4 Lacquered laminate, alpine white ultra matt	EASYTOUCH 969 PG 4 Lacquered laminate, sand ultra matt	CASCADA 776 PG 7 Lacquered laminate, reed green	NORDIC 782 PG 7 Lacquer, honed white	SYLT 847 PG 7 Lacquer, honed alpine white	SYLT 849 PG 7 Lacquer, honed ivory	SYLT 851 PG 7 Lacquer, honed black	CASTELLO 390 PG 8 Washed ivory
											
EASYTOUCH 963 PG 4 Lacklaminat, Rostrot ultramatt	EASYTOUCH 961 PG 4 Lacklaminat, Grafit schwarz ultramatt	STONEART 304 PG 4 Lack, Schiefer steingrau Nachbildung	STONEART 303 PG 4 Lack, Grauschiefer Nachbildung	INOX 216 PG 4 Lacklaminat, Stahl gebürstet Nachbildung	FASHION 168 PG 4 Lack, Alpinweiß matt	LUX 817 PG 9 Lack, Alpinweiß Hochglanz	LUX 814 PG 9 Lack, Weiß Hochglanz	LUX 816 PG 9 Lack, Magnolia Hochglanz	LUX 819 PG 9 Lack, Seidengrau Hochglanz	LUX 823 PG 9 Lack, Schiefergrau Hochglanz	PURA 834 PG 9 Lack, Weiß Hochglanz
EASYTOUCH 963 PG 4 Lacquered laminate, rust red ultra matt	EASYTOUCH 961 PG 4 Lacquered laminate, graphite black ultra matt	STONEART 304 PG 4 Stone grey slate reproduction	STONEART 303 PG 4 Grey slate reproduction	INOX 216 PG 4 Lacquered laminate, brushed steel reproduction	FASHION 168 PG 4 Lacquer, honed alpine white	LUX 817 PG 9 Lacquer, alpine white high gloss	LUX 814 PG 9 Lacquer, white high gloss	LUX 816 PG 9 Lacquer, ivory high gloss	LUX 819 PG 9 Lacquer, satin grey high gloss	LUX 823 PG 9 Lacquer, slate grey high gloss	PURA 834 PG 9 Lacquer, white high gloss
											
FASHION 173 PG 4 Lack, Weiß matt	FASHION 175 PG 4 Lack, Magnolia matt	FASHION 171 PG 4 Lack, Seidengrau matt	FASHION 165 PG 4 Lack, Steingrau matt	FOCUS 470 PG 4 Lack, Alpinweiß Ultra-Hochglanz	FOCUS 460 PG 4 Lack, Weiß Ultra-Hochglanz	CHALET 883 PG 9 Lack, Magnolia matt	CHALET 881 PG 9 Lack, Sand matt	YORK 905 PG 9 Echtholz, Magnolia lackiert	YORK 901 PG 9 Echtholz, Seidengrau lackiert	ARTIS 937 PG 10 Glasoptik, Titanio matt	
FASHION 173 PG 4 Lacquer, honed white	FASHION 175 PG 4 Lacquer, honed ivory	FASHION 171 PG 4 Lacquer, honed satin grey	FASHION 165 PG 4 Lacquer, honed stone grey	FOCUS 470 PG 4 Lacquer, alpine white ultra high gloss	FOCUS 460 PG 4 Lacquer, white ultra high gloss	CHALET 883 PG 9 Lacquer, honed ivory	CHALET 881 PG 9 Lacquer, honed sand	YORK 905 PG 9 Genuine wood, lacquered ivory	YORK 901 PG 9 Genuine wood, lacquered satin grey	ARTIS 937 PG 10 Glass appearance, Titanio matt	

ARBEITSPLATTENEKORE WORKTOP DÉCORS

 066 Schiefer Nachbildung 066 Slate décor reproduction	 070* Seidengrau 070* Satin grey	 078 Eiche San Remo Nachbildung 078 Sanremo oak reproduction	 089* Steingrau 089* Stone grey	 097 Eiche Havanna Nachbildung 097 Havana oak reproduction	 117 Copper Vintage Nachbildung 117 Vintage Copper décor
 123 Eiche Virginia Nachbildung 123 Virginia oak reproduction	 124* Nussbaum Nachbildung 124* Walnut reproduction	 149* Beton Terragrau Nachbildung 149* Concrete Terra grey reproduction	 192 Eiche Provence Nachbildung 192 Oak Provence reproduction	 193* Alpinweiß 193* Alpine white	 194* Schiefergrau 194* Slate grey
 198 Eiche Sierra Nachbildung 198 Sierra oak reproduction	 215 Stromboli hell Nachbildung 215 Strombolian light reproduction	 220 Arizona Pine Nachbildung 220 Arizona pine reproduction	 225 Stammeiche Nachbildung 225 Stern oak reproduction	 226 Dekor Metal Art Nachbildung 226 Metal art décor	 265 Rusty Plates Nachbildung 265 Rusty plates reproduction
 266 Caledonia 266 Caledonia	 272 Balkeneiche Nachbildung 272 Timber oak reproduction	 273 Carrara Nachbildung 273 Carrara marble reproduction	 274 Marmor Teramo Nachbildung 274 Teramo marble reproduction	 319 Dekor Oxid 319 Oxid décor	 330* Beton grau Nachbildung 330* Concrete grey reproduction
 344* Granit schwarz geflammt Nachbildung 344* Black granite décor	 345 Eiche Yukon Nachbildung 345 Yukon oak reproduction	 347 Taxus Nachbildung 347 Taxus reproduction	 352 Eiche Halifax Nachbildung 352 Sherwood oak reproduction	 353* Weißbeton Nachbildung 353* White Concrete reproduction	 354* Beton schiefergrau Nachbildung 354* Concrete Slate Grey reproduction
 355* Ferro Bronze Nachbildung 355* Ferro bronze décor	 356 Endgrain Oak Nachbildung 356 Endgrain oak reproduction	 366* Schwarz strukturiert 366* Black textured	 376* Limestone Nachbildung 376* Limestone reproduction	 378 Schwarzbeton Nachbildung 378 Black Concrete reproduction	 379 Eiche Somerset Nachbildung 379 Somerset oak reproduction
 393 Vintage Oak Nachbildung 393 Vintage oak reproduction	 394 Travertin sandbeige Nachbildung 394 Champagne travertine reproduction	 395 Verso Nachbildung 395 Verso reproduction	 396 Terrazzo grau Nachbildung 396 Grey terrazzo reproduction	 Arbeitsplatte APN mit N-Kante Worktop APN with N edge	 Arbeitsplatte APD mit Dekorkante Worktop APD with décor edge

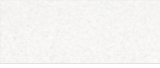
QUARZSTEIN QUARTZ STONE







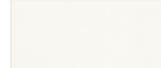
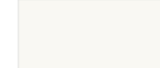
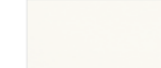
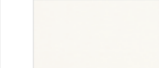
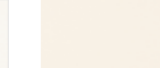
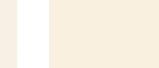

 806** Quarzstein Epic White 806** Quartz stone Epic White	 802** Quarzstein Epic Raw 802** Quartz stone Epic Raw	 804** Quarzstein Epic Black 804** Quartz stone Epic Black
--	--	---

** Auch als 12 mm starke Arbeitsplatte lieferbar.
** Also available as 12 mm thick worktop.

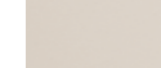









XTRA

 364* Dolerit Nachbildung 364* Basalt reproduction	 369* Schiefer steingrau Nachbildung 369* Stone grey slate reproduction	 373* Grauschiefer Nachbildung 373* Grey slate reproduction	 367* Eiche Artisan Nachbildung 367* Artisan oak reproduction	
--	---	---	--	---

KORPUSDEKORE CARCASE DÉCORS











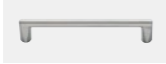

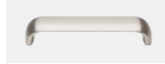
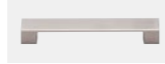

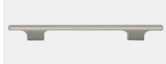

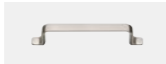

 193 Alpinweiß 193 Alpine white	 060 Alpinweiß Glanz 060 Alpine white gloss	 106 Weiß 106 White	 022 Weiß Glanz 022 White gloss	 120 Magnolia matt 120 Ivory matt	 116 Magnolia Glanz 116 Ivory gloss
 070 Seidengrau 070 Satin grey	 089 Steingrau 089 Stone grey	 122 Sand 122 Sand	 194 Schiefergrau 194 Slate grey	 127 Schwarz 127 Black	 123 Eiche Virginia Nachbildung 123 Virginia oak reproduction
 078 Eiche San Remo Nachbildung 078 Sanremo oak reproduction	 198 Eiche Sierra Nachbildung 198 Sierra oak reproduction	 097 Eiche Havanna Nachbildung 097 Havana oak reproduction			

COLOR CONCEPT COLOR CONCEPT

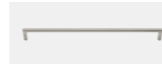

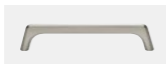
 241 Sonnegelb 241 Maize Yellow	 038 Schilf 038 Reed green	 248 Farn 248 Fern	 254 Aqua 254 Aqua	 265 Rusty Plates Nachbildung 265 Rusty plates reproduction	 266 Caledonia 266 Caledonia
 272 Balkeneiche Nachbildung 272 Timber oak reproduction	 273 Carrara Nachbildung 273 Carrara marble reproduction	 274 Marmor Teramo Nachbildung 274 Teramo marble reproduction	 355 Ferro Bronze Nachbildung 355 Ferro bronze décor		

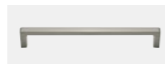
GRIFFAUSWAHL HANDLE SELECTION

Griffe Edelstahlfarbig Handles in stainless steel finish

					
019* Metallgriff Edelstahlfarbig	042 Metallgriff Edelstahlfarbig	062 Metallgriff Edelstahlfarbig	067 Metallgriff Edelstahlfarbig	069 Metallgriff Edelstahlfarbig	077 Metallgriff Edelstahlfarbig
019* Metal handle Stainless steel finish	042 Metal handle Stainless steel finish	062 Metal handle Stainless steel finish	067 Metal handle Stainless steel finish	069 Metal handle Stainless steel finish	077 Metal handle Stainless steel finish
					
098 Metallgriff Nickel matt	121 Metallgriff Edelstahlfarbig	183 Metallgriff Edelstahlfarbig	186 Metallgriff Edelstahlfarbig	218 Metallgriff Edelstahlfarbig / Chrom Glanz	221 Metallgriff Edelstahlfarbig
098 Metal handle Matt nickel	121 Metal handle Stainless steel finish	183 Metal handle Stainless steel finish	186 Metal handle Stainless steel finish	218 Metal handle Stainless steel finish / Brilliant chrome	221 Metal handle Stainless steel finish
					
237 Metallgriff Edelstahlfarbig	263 Metallgriff Edelstahlfarbig	279 Metallgriff Edelstahlfarbig	331 Metallgriff Edelstahlfarbig	408 Metallgriff Edelstahlfarbig	409* Bügelgriff Edelstahlfarbig
237 Metal handle Stainless steel finish	263 Metal handle Stainless steel finish	279 Metal handle Stainless steel finish	331 Metal handle Stainless steel finish	408 Metal handle Stainless steel finish	409* Bow handle Stainless steel finish
					
544 Metallgriff Edelstahlfarbig	552 Metallgriff Edelstahlfarbig	602 Metallgriff Edelstahlfarbig	608 Metallgriff Edelstahlfarbig	708 Metallgriff Edelstahlfarbig	801 Metallgriff Edelstahlfarbig
544 Metal handle Stainless steel finish	552 Metal handle Stainless steel finish	602 Metal handle Stainless steel finish	608 Metal handle Stainless steel finish	708 Metal handle Stainless steel finish	801 Metal handle Stainless steel finish

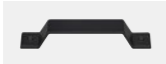
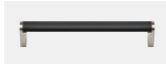

Griffe Anthrazit / Schwarz Handles in Anthracite / Black

			
563 Metallgriff Schwarz / Edelstahlfarbig	570 Metallgriff Schwarz	595 Metallgriff Schwarz / Edelstahlfarbig	616 Gusseisengriff Schwarz
563 Metal handle Black / Stainless steel finish	570 Metal handle Black	595 Metal handle Black / Stainless steel finish	616 Cast iron handle Black













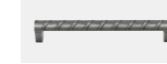

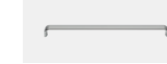
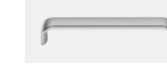

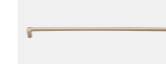

Knöpfe Knobs

		
610 Gusseisenknopf Schwarz	677 Metallknopf Edelstahlfarbig	679 Metallknopf Schwarz
610 Cast iron knob Black	677 Metal knob Stainless steel finish	679 Metal knob Black











Holzgriffe Wooden handles

	
199* Holzgriff Eiche	737* Holz-Metallgriff Eiche / Schwarz
199* Wooden handle Oak	737* Wood / Metal handle Oak / Black



Griffe mit Effektveredelung Handles with effect finishing

					
088 Metallgriff Anthrazit gebürstet	099 Metallgriff Industrial Style	118 Metallgriff Altsilberfarbig	119 Metallgriff Altsilberfarbig	190* Bügelgriff Chrom Glanz	192 Metallgriff Chrom Glanz
088 Metal handle Brushed anthracite	099 Metal handle Industrial Style	118 Metal handle Antique silver colour	119 Metal handle Antique silver colour	190* Bow handle Brilliant chrome	192 Metal handle Brilliant chrome
					
222 Metallgriff Goldfarbig	223* Bügelgriff Goldfarbig	271 Metallgriff Titanfarbig	280 Metallgriff Alteisenfarbig	284 Metallgriff Altsilberfarbig	358 Metallgriff Titanfarbig
222 Metal handle Gold-coloured	223* Bow handle Gold-coloured	271 Metal handle Titanium-coloured	280 Metal handle Antique iron colour	284 Metal handle Antique silver colour	358 Metal handle Titanium-coloured
					
498 Metallgriff Chrom Glanz	499* Bügelgriff Chrom Glanz	509 Metallgriff Grau	511 Metallgriff Titanfarbig	514* Bügelgriff Titanfarbig	515* Bügelgriff Titanfarbig
498 Metal handle Brilliant chrome	499* Bow handle Brilliant chrome	509 Metal handle Grey	511 Metal handle Titanium-coloured	514* Bow handle Titanium-coloured	515* Bow handle Titanium-coloured
					
799 Metallgriff Schwarzchrom					
799 Metal handle Chromed black					

Griffleisten Bar handles

					
240* Griffleiste Schwarz	300* Griffleiste Edelstahlfarbig	350* Griffleiste Edelstahlfarbig	430* Griffleiste Edelstahlfarbig	550* Griffleiste Edelstahlfarbig	600* Griffleiste Schwarz
240* Bar handle Black	300* Bar handle Stainless steel finish	350* Bar handle Stainless steel finish	430* Bar handle Stainless steel finish	550* Bar handle Stainless steel finish	600* Bar handle Black
					
690* Griffleiste Alpenweiß	710* Griffleiste Steingrau	730* Griffleiste Schiefergrau	760* Griffleiste Edelstahlfarbig	870* Griffleiste Schwarz	
690* Bar handle Alpine white	710* Bar handle Stone grey	730* Bar handle Slate grey	760* Bar handle Stainless steel finish	870* Bar handle Black	

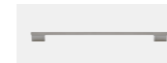
Relingstangen Railing handles

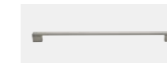
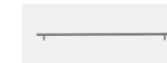
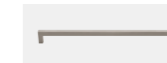
				
370* Relingstange Edelstahlfarbig	620* Relingstange Schwarz	650* Relingstange Edelstahlfarbig	900* Relingstange Edelstahlfarbig	930* Relingstange Edelstahlfarbig
370* Railing handle Stainless steel finish	620* Railing handle Black	650* Railing handle Stainless steel finish	900* Railing handle Stainless steel finish	930* Railing handle Stainless steel finish

ALLES AUS EINER HAND EVERYTHING FROM A SINGLE SOURCE

Vom Wohnzimmer über den Speiseraum bis hin zu Küche und Bad: Das flexible System und die große Auswahl an Fronten und Oberflächen machen es möglich, das Zuhause in einem Stil oder jeden Raum ganz unterschiedlich zu kreieren. Und das in gewohnter nobilia Qualität. Möbel made in Germany.

From the living room and dining room to the kitchen and bathroom: the flexible system and large selection of fronts and surfaces make it possible to decorate your home in a single style or design each room differently. And of course in the usual nobilia quality. Furniture made in Germany.



**Qualität
made in Germany**
Quality
made in Germany

Ausgesuchte Materialien, exzellente Verarbeitung, Perfektion bis ins Detail: Unsere Möbel werden nach höchsten Qualitätskriterien entwickelt und gefertigt. Dabei produzieren wir ausschließlich am Standort Deutschland.

Bevor unsere Produkte in Serie gehen, werden alle eingesetzten Materialien in umfangreichen Testverfahren im Labor auf eine Mindestlebensdauer von 15 Jahren geprüft und durch internationale, unabhängige Institute kontrolliert und zertifiziert. Denn die Zufriedenheit unserer Kunden ist für uns der höchste Maßstab.

Selected materials, excellent workmanship, perfection right down to the finest detail: our furniture is developed and manufactured according to the highest of quality standards. Our products are made exclusively in Germany.

Before our products go into series production, all the materials used are subjected to extensive test procedures in the laboratory for a minimum service life of 15 years and inspected and certified by independent international institutes. After all, our customers' satisfaction is our benchmark.





nobilia-Werke
J. Stickling GmbH & Co. KG
Waldstraße 53-57
33415 Verl
info@nobilia.de
www.nobilia.de

Wohnmagazin 2021

92090



DE/EN